



# HILTI CORDLESS STUD FUSION

Technical Manual



May 2023  
Revision 1, January 2025

# CONTENTS

<b>Preface</b>	<b>4</b>
<b>1 Introduction</b>	<b>5</b>
<b>2 Application information</b>	<b>6</b>
2.1 Applications	6
<b>3 Cordless Stud Fusion (CSF) technology</b>	<b>7</b>
3.1 Cordless Stud Fusion (CSF) equipment	7
3.2 Cordless Stud Fusion (CSF) surface preparation	11
3.3 Cordless Stud Fusion (CSF) welding process	13
3.4 Cordless Stud Fusion (CSF) welding parameters	14
3.5 Cordless Stud Fusion (CSF) energy regulation	15
3.6 Cordless Stud Fusion (CSF) magnetic arc control	16
3.7 Cordless Stud Fusion (CSF) welding protection	16
3.8 Active Fusion Indicator (AFI)	17
<b>4 F-BT stud description</b>	<b>18</b>
4.1 Stud designation	18
4.2 Stud design principles	19
4.3 Stud recommendation	20
4.4 Corrosion resistance and durability through sealing	22
4.5 Requirements for corrosion protection	23
4.6 Structural load types	24
<b>5 Technical data for F-BT-MR SN</b>	<b>25</b>
5.1 Stud specification	25
5.2 Application recommendation	28
5.2.1 Application area	28
5.2.2 Fastened material	28
5.2.3 Parent material	29
5.3 Performance data	30
5.4 Installation recommendations	33
5.4.1 Stud installation	33
5.4.2 Sealing washer installation inspection	33
5.4.3 Installation torque	33
<b>6 Technical data for F-BT-MR</b>	<b>34</b>
6.1 Stud specification	34
6.2 Application recommendation	35
6.2.1 Application area	35
6.2.2 Fastened material	35
6.2.3 Parent material	36
6.3 Performance data	37
6.4 Installation recommendations	39
6.4.1 Stud installation	39
6.4.2 Installation torque	39

<b>7</b>	<b>design concept</b>	<b>40</b>
7.1	Partial factor method	40
7.2	Working load concept	40
7.3	Load interaction	41
<b>8</b>	<b>Cordless Stud Fusion (CSF) in keeping with EN ISO 14555</b>	<b>42</b>
8.1	Welding Procedure Qualification (WPQ)	43
8.1.1	pre-liminary Welding Procedure Specification (pWPS)	43
8.1.2	Welding procedure qualification test (WPQT)	44
8.1.3	Welding Procedure Qualification Record (WPQR)	44
8.1.4	Qualified Welding Procedure Specification (WPS)	44
8.1.5	Conditions related to parent material	45
8.1.6	Conditions related to stud material	46
8.1.7	Conditions related to welding positions	46
8.2	Process control	47
8.2.1	Production test	47
8.2.2	Simplified production test	48
8.2.3	Production surveillance	48
8.3	Cordless Stud Fusion (CSF) personnel	49
8.3.1	Inspection personnel	49
8.3.2	Technical review	49
8.3.3	Inspection record	49
8.3.4	Operator personnel	50
8.4	Visual examination and physical examination details	50
8.4.1	Destructive testing (DT) – bend testing	50
8.4.2	Destructive testing (DT) – tension test	51
8.4.3	Non-destructive testing (NDT) – tension test (HAT 28-FX)	51
8.5	Technical reports	52
8.5.1	WPQR, macro examinations and hardness measurements	52
8.5.2	Tension tests	52
8.5.3	Shear tests	53
8.6	Terms and definitions	54
8.7	Abbreviations	55
<b>9</b>	<b>SPECIFIC ASPECTS OF PERFORMANCE</b>	<b>56</b>
9.1	Impact of F-BT weldments on parent material fatigue strength	56
<b>10</b>	<b>Cordless Stud Fusion (CSF) program</b>	<b>58</b>
10.1	Surface preparation equipment	58
10.2	Stud fusion equipment	58
10.3	Installation equipment	59
10.4	Studs	59
10.5	Support plate	60
10.6	Test equipment	60
<b>11</b>	<b>References</b>	<b>61</b>

## PREFACE

At Hilti, we are committed to investing in technology to support and further drive productivity of the construction industry. Hilti Cordless Stud Fusion (CSF) provides customers with a fully cordless system with built-in process controls to install high quality stud welds consistently and safely.

The objectives of this Technical Manual are the following:

- Introduce the CSF system and technology
- Provide guidance to ensure the quality of surface preparation
- Provide guidance to ensure the quality of stud welding
- Offer technical specifications and load data for the F-BT studs
- Provide guidance and resources for implementation of CSF on jobsites

This Technical Manual covers stud fusion of metallic materials subject to static loading. It provides requirements and recommendations relating to stud fusion, including preparation, installation, product specification, welding procedure specification and qualification, process control, and qualification testing of operators.

This manual provides guidance for project specific design, qualification, and installation in keeping with the following welding standards, however CSF is not solely limited to use with these standards:

- EN ISO 14555 [5]
- AWS D1.6/D1.6M [14]

The parent materials covered in this Technical Manual are the following standardized materials:

- 1.1 and 1.2 according to CEN ISO/TR 15608 [8]
- ASTM A36 and ASTM A752 Grade 50 according to AWS B2.1 [12]

Parent materials not identified to the standard nominated above may be used provided one of the following requirements are met:

- Testing parent materials, to determine compliance with the aforementioned steel grades.
- Comparing parent material test certificates, to determine compliance with the nominated steel grades.

This Technical Manual is intended for use in all fields of the metal-working industry.

### NOTE

Revision 1, January 2025: Bending moment adjusted for stud type F-BT-MR 3/8xL SN (5/32) in Table 5.3.1 and 5.3.2.

# 1 INTRODUCTION

Engineers, manufacturers, contractors, and a range of other professionals use stud welding to attach studs to steel of varying materials and thicknesses.

The Cordless Stud Fusion (CSF) welding process is classified as a drawn arc (DA) stud welding process with shielding gas (welding process 783 according to EN ISO 14555). The drawn arc stud weld process utilizes a welding power supply to create an electric arc along a circuit created between the stud and parent material. The electric arc travels between the two materials via an air gap, generating an intense, concentrated heat used to melt the stud's base and a small area of the parent material. Once the materials are melted appropriately, the stud is plunged into the molten area and held in place as the metals solidify to form the welded connection.

The timing, voltage, current, plunge and other aspects of the weld process are fully controlled by the CSF system, with power turning off automatically, negating the need for fine tuning by an operator.

Benefits of Cordless Stud Fusion (CSF):

- Compact and portable system, with no need for external power source
- Adjustment free hand tool and fully automated welding process
- Consistent and spark free process
- Lightweight and convenient shielding gas
- Easy to learn welding process
- No ferrule required

Welding codes and standards address all aspects of design and fabrication of welded components, including welding procedure qualification, testing methods, process control, and operator qualifications.

It is therefore important to understand the requirements of the relevant welding codes and standards to ensure stud welding is completed effectively and safely. This technical manual provides guidance relative to these standards.

## 2 APPLICATION INFORMATION

The purpose of Cordless Stud Fusion (CSF) is to weld studs to construction steel workpieces. Modern fastening technology is increasingly important in shipbuilding, on- and off-shore structures, modern construction industry and structural engineering worldwide. Among others, Cordless Stud Fusion (CSF) is used in following application groups:

- Multi-disciplinary support
- Welded support for cable trays
- Modular support for cable trays
- Individual support
- Welded support for pipe trays
- Modular support for pipes
- Suspended ceiling
- Equipment fastening
- Shipbuilding fastening

### 2.1 Applications

Representative services within the applications groups are pipes, conduits electrical services, control services, instrumental services and telecommunication services. Typical shipbuilding fastenings are false ceiling fastening, outfitting and inspection grids. Figure 2.1-1 shows various application examples.

Applications		
Multi-disciplinary support	Welded support for cable trays	Modular support for cable trays
Individual support	Welded support for pipe trays	Modular support for pipes
Suspended ceilings	Shipbuilding fastenings	Equipment fastenings

Figure 2.1-1: Applications

## 3 CORDLESS STUD FUSION (CSF) TECHNOLOGY

This section gives an overview on the Cordless Stud Fusion (CSF) technology.

### 3.1 Cordless Stud Fusion (CSF) equipment

In this section an overview of Cordless Stud Fusion (CSF) equipment is given. It is subdivided as follows:

- Surface preparation equipment
- Stud fusion equipment
- Installation equipment
- Testing equipment

The correct functioning of the Cordless Stud Fusion (CSF) equipment shall be ensured by the manufacturer. During production, a function check shall be performed at fixed intervals. Cables, connection elements, mechanical guides and fixtures and stud holders shall be regularly checked and replaced if excessive wear or damage has occurred.

---

#### Surface preparation equipment

---



Cordless drill driver: SF 8M-A22

- It is recommended to hold the drill with the other hand at the back of the drill.



Cordless hammer drill driver: SF 6H-22

- It is recommended to hold the drill with the other hand at the back of the drill.



Surface tool FX 3-ST d14

- Black steel with mill scale
- Weldable primer with maximum coating thickness: 25 µm



Surface tool FX 3-ST d20

- Non-weldable primer
  - HDG coating
  - Multi-layer coating
  - Maximum coating thickness: 1000 µm
- 

Figure 3.1-1: Surface preparation equipment

**Stud fusion equipment**



**Cordless stud fusion unit FX 3-A**

- Battery powered
- Fully automatic
- Cordless stud fusion unit with one touch control panel
- Based on selected welding code H1, H2, H3 or H10, all welding parameters are set

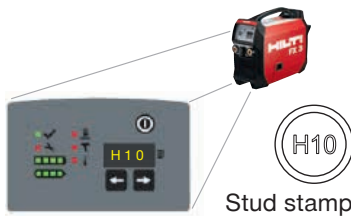

**One touch control panel**

- Electrical and mechanical process parameters are pre-set based on selected H-code
- Required H-code is stamped on top of each stud



**Gas can FX 3-GC for use in the Cordless stud fusion unit**

- Shielding gas (SG): ISO 14175 – M21 – ArC-18:
  - 82% Ar (CAS 7440-37-1)
  - 18% CO<sub>2</sub> (CAS 124-38-9)



**Stud fusion hand tool FX 3-HT**

- All studs work on the same hand tool
- Stud holder is changed to adjust stud diameter
- Auto adjustment to stud length



**Stud holder**

- X-SH F3 M6-1/4"



**Stud holder**

- X-SH F3 M8-5/16"

**Figure 3.1-2: Stud fusion equipment – part I**



---

**Stud fusion equipment**

---



- Stud holder
- X-SH F3 M10-3/8"



- Stud holder
- X-SH F3 M12-1/4"



- Support leg X-SL F3
- Support leg for perpendicular welding



- Charger C 53
- Charging the cordless stud fusion unit
  - Quick charge button available



- Ground cable X-GC F3
- Close electrical circuit



- Magnetic ground clamp X-MC F3
- Close electrical circuit



- Stud holder change tool X-SHT F3
- Shall be used to exchange the stud holder

---

**Figure 3.1-3: Stud fusion equipment – part II**

---

### Installation equipment

---



Sealing washer setting tool X-WST F3-BT

- Setting tool with different adapters can be used for metric (M6, M8, M10, M12) and imperial (3/8", 1/2") studs
  - M6: green
  - M8: yellow
  - M10/ 3/8": red
  - M12/ 1/2": blue

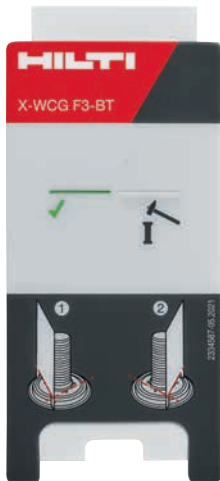

Checking Gauge X-WCG F3-BT

Figure 3.1-4: Installation equipment

---

### Support plate



Support plates are available as an option to help with load distribution for F-BT-MR SN studs with sealing washers. The plate is installed at the base of the stud around the washer, to provide an even surface for the fastened material to act upon. This helps to transfer bending moment effects to the base or parent material.

Figure 3.1-5: Support plate

---

### Measuring and testing equipment



The product described is a specific system for testing studs. It consists of a mechanical screw jack passing through a hydraulic load cell which directly measures the load applied to the stud.

Figure 3.1-6: Measuring and testing equipment

---

### 3.2 Cordless Stud Fusion (CSF) surface preparation

Surface preparation before joining is a mandatory step to ensure the integrity of the welded joint. It is necessary to ensure that the parent material surface is clean, free from scale and coatings, dry and free from organic materials. The surface preparation process not only cleans the steel, but also provides a suitable surface profile to achieve acceptable welding results. To provide reliable weld performance across variance of coatings and steel surfaces, the welding surface needs to be prepared with the recommended Hilti surface tools. This section provides the surface preparation steps, surface tool selection and the surface inspection guidelines for different parent material coating types.

---

#### Surface preparation

---

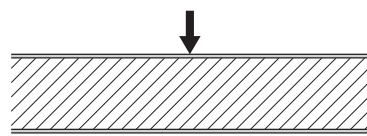

##### Mark stud location

- Use a center punch to mark the stud location

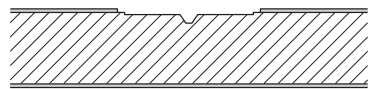

##### Prepare surface

- Coated parent material: remove coating
- Uncoated parent material: remove rust, dirt, contaminants
- Use drilling tool SF 8M-A22 or SF6(H)-22
- Adjust cordless screwdriver to correct speed
- Select gear according to Instructions for Use (IFU)/Operators Instructions (OI):
  - SF 8M-A22: gear 3 (1'250 rpm)
  - SF 6H-22: gear 2 (2'000 rpm)
- Insert the recommended surface tool appropriate to the parent material based on Figure 3.1-2 below
- Missing step – Prepare surface per IFU

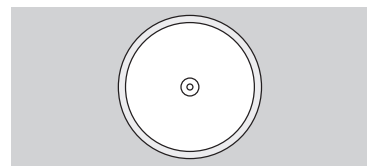

---

**Figure 3.2-1: Surface preparation**

Figure 3.2-2 shows the surface tool recommendation for different parent material, coating types and thicknesses with an assignment to the corresponding studs.



Surface tool recommendation			
Surface tool	FX 3-ST d14	FX 3-ST d20	FX 3-ST d20
			
Parent material coating	Type I Weldable primer Black steel with mill scale	Type II Non-weldable primer HDG coating Duplex coating Multi-layer coating	Type II Non-weldable primer HDG coating Duplex coating Multi-layer coating
Parent material coating thickness	$t_c \leq 25 \mu\text{m}$	$t_c \leq 1000 \mu\text{m}$	$t_c \leq 1000 \mu\text{m}$
			
Stud type	F-BT-MR	F-BT-MR	F-BT-MR SN

Figure 3.2-2: Surface tool recommendation

The cleaned weld area shall be inspected for adequate surface preparation. Recommended surface preparation depth is given in Figure 3.2-3.

### Surface preparation recommendation

Parent material coating type I		Designation	Diameter of prepared surface	Recommended surface preparation depth
			$d_p$	x
		Metric size		
		FX 3-ST d14	14 mm	0.2 mm
		Imperial size		
FX 3-ST d14	0.551"	0.008"		
Parent material coating type II		Designation	Diameter of prepared surface	Shiny ring height
			$d_p$	x
		Metric size		
		FX 3-ST d20	20 mm	0.2 mm
		Imperial size		
FX 3-ST d20	0.787"	0.008"		

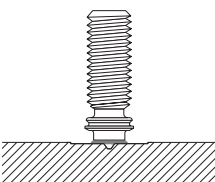
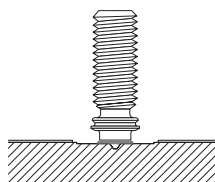
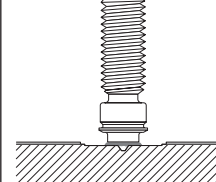
Figure 3.2-3: Surface preparation recommendation

Surface depth is 0.2 mm lower than the shiny ring. Prepared surface shall look shiny polished. The inspection in detail is provided in following technical documents: Hilti F-BT visual examination catalogue [10] and Instructions for use (IFU).

### 3.3 Cordless Stud Fusion (CSF) welding process

CSF is a drawn-arc technique (783) where a stud is welded onto a steel parent material by heating both parts with an arc. It is carried out with shielding gas.

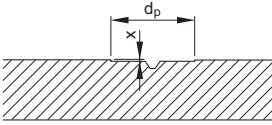
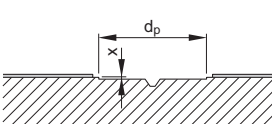
#### Stud fusion

- Easy and ergonomic operation.
- Fully computer-controlled and automated cordless stud fusion unit.
- Ability to change stud holder allows for one hand tool to accommodate various stud sizes.

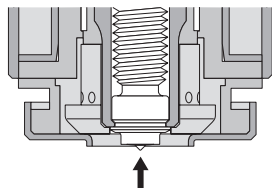

#### Prepare stud fusion

- Identify stud H-code
- Adjust the tool by selecting the welding code (H-code)
- Press stud into tool front until it clearly clicks into place

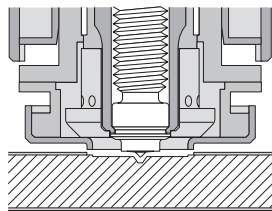

#### Position stud

- Position stud tip over the center of the prepared surface

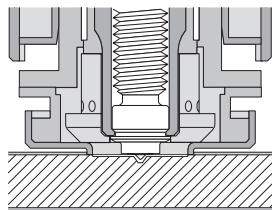

#### Compress hand tool to base material

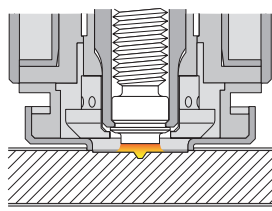

#### Start stud fusion process

- Trigger the tool
- Welding process is automatically started
- Stud is automatically lifted
- Arc is automatically ignited
- Arc melts stud base and parent material
- Stud is automatically plunged into the molten material
- Arc is extinguished and metal cools down

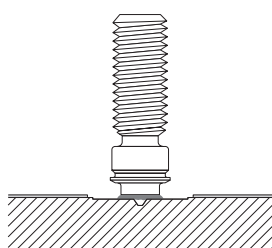
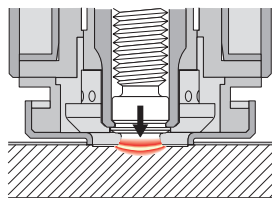

#### Inspect stud

- Remove tool
- Inspect weld joint

Figure 3.3-1: CSF welding process

### 3.4 Cordless Stud Fusion (CSF) welding parameters

The basic parameters to describe the Cordless Stud Fusion (CSF) process are as follows:

- Polarity
- Welding current
- Welding time
- Protrusion
- Lift
- Welding protective

Polarity indicates direction of flow of current between the stud and the parent material in the external circuit. Direct current (DC) flows in one direction, which results in constant DC polarity. In the weld circuit, the stud is negative and the parent material positive, resulting in a flow of electrons from stud to parent material. The welding current and welding time are controlled via the Weld code (H-code) on the FX 3-A tool and correspond to the stud diameter. The welding energy is constant throughout the Cordless Stud Fusion (CSF) process for each welding code. For more information regarding energy regulation see section 3.5. The process is protected by a shielding gas system, which is further detailed in section 3.7.

**Basic parameter of CSF welding process**

Designation	H-Code	Welding Current	Welding time	Protrusion	Lift	Welding protective
Metric						
F-BT-MR M6 x L (6)	H2	250 to 280 A	150 to 180 ms	4.2 to 4.6 mm	2.3 to 2.8 mm	Shielding gas and arc control with magnetic field
F-BT-MR M8 x L (8)	H3		245 to 285 ms	4.4 to 4.8 mm		
F-BT-MR M10 x L (10)	H10		390 to 440 ms	4.4 to 4.8 mm		
F-BT-MR M12 x L (10)	H10		390 to 440 ms	4.4 to 4.8 mm		
F-BT-MR M6 x L SN (4)	H1	250 to 280 A	80 to 110 ms	4.2 to 4.6 mm	2.3 to 2.8 mm	Shielding gas and arc control with magnetic field
F-BT-MR M8 x L SN (4)	H1		80 to 110 ms	4.2 to 4.6 mm		
F-BT-MR M6 x L SN (6)	H2		150 to 180 ms	4.2 to 4.6 mm		
F-BT-MR M8 x L SN (8)	H3		245 to 285 ms	4.4 to 4.8 mm		
F-BT-MR M10 x L SN (10)	H10		390 to 440 ms	4.4 to 4.8 mm		
F-BT-MR M12 x L SN (10)	H10		390 to 440 ms	4.4 to 4.8 mm		
Imperial						
F-BT-MR 3/8 x L SN (5/32)	H1	250 to 280 A	80 to 110 ms	4.2 to 4.6 mm	2.3 to 2.8 mm	Shielding gas and arc control with magnetic field
F-BT-MR 3/8 x L (3/8)	H10		390 to 440 ms	4.4 to 4.8 mm		
F-BT-MR 1/2 x L (3/8)	H10		390 to 440 ms	4.4 to 4.8 mm		
F-BT-MR 3/8 x L SN (3/8)	H10	250 to 280 A	390 to 440 ms	4.4 to 4.8 mm	2.3 to 2.8 mm	Shielding gas and arc control with magnetic field
F-BT-MR 1/2 x L SN (3/8)	H10		390 to 440 ms	4.4 to 4.8 mm		

**Table 3.4-1: Basic parameters**

Lift is the distance between the stud tip and the parent material within the stud fusion process.

---

### Protrusion

---

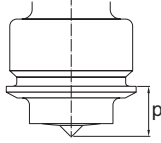

Protrusion p

- Distance between the tip of the stud and the stud holder interface

---

Figure 3.4-1: Protrusion

## 3.5 Cordless Stud Fusion (CSF) energy regulation

The FX 3-A energy source supplies consistent power through the weld process to deliver appropriate energy is delivered into the materials. This is achieved by regulating the current and voltage. Below is a sample of energy regulation, by adjusting the power via voltage and current.

If a change in resistance occurs, the energy source automatically responds by adjusting the current and voltage accordingly, therefore regulating the power delivered.

---

### Power regulation over time for weld process

---

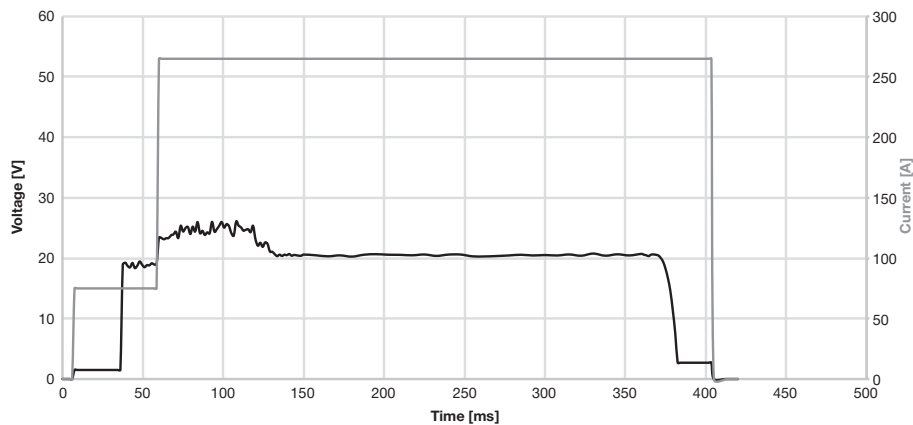

---

Figure 3.5-1: Power regulation over time for weld process

### 3.6 Cordless Stud Fusion (CSF) magnetic arc control

Cordless Stud Fusion (CSF) is a drawn arc welding (DA) where the arc is controlled by magnetic field. During the Cordless Stud Fusion (CSF) process a magnetic field is created around the arc. When stud welding, magnetic blowing effects due to irregular current distribution in the parent material can reduce weld quality. To minimize and control magnetic blowing effects, the CSF system provides arc control through the use of a magnetic field, for more detail see Figure 3.6-1.

#### Arc control by magnetic field

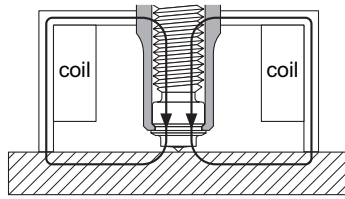

Cordless Stud Fusion (CSF) has an inbuilt arc control through a magnetic field which directs and shapes the arc. The magnetic field is created around the arc to precisely position, oscillate and stabilize it. By this, the magnetic field counteracts arc blow.

Figure 3.6-1: Arc control by magnetic field

### 3.7 Cordless Stud Fusion (CSF) welding protection

The welding protection is ensured by a shielding gas system. The main features of the shielding gas system are the gas itself, the gas flow distribution, and the distribution ring.

#### Shielding gas

M21-ArC-18  
according to EN ISO 14175 [4]

The shielding gas has a composition of 18 % carbon dioxide in argon. The product is standardized according to EN ISO 14175. M21-ArC-18 is integrated in the M21 group. Argon is a noble gas with low reactivity, which helps to protect the welding process from reacting with the surrounding atmosphere.

Table 3.6-1: Shielding gas

The gas flow rate is 3 l/min. Figure 3.7-1 shows the gas flow distribution.

#### Gas flow distribution

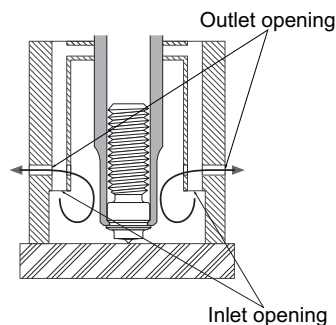

The gas flow is constant and flows as shown in the diagram to the left. It covers the welding zone through the complete welding process. The arc-shaped gas flow characteristic prevents oxidation by avoiding gas turbulences.

Figure 3.7-1: Gas flow distribution

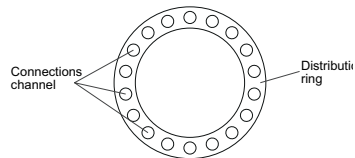

Figure 3.7-2 shows the distribution ring.

---

### Distribution ring

---



The distribution ring functions as a gas diffuser to ensure uniform gas distribution over the stud element connected with the parent material. It is designed for lower pressure so that the shielding can be achieved with the gas can FX 3-GC implemented in the Cordless Stud Fusion (CSF) unit FX 3-A.

---

Figure 3.7-2: Distribution ring

## 3.8 Active Fusion Indicator (AFI)

---

### Active Fusion Indicator (AFI)

---



Hilti-FX-3 tool has an inbuilt process control helping to detect failures before, during or after the welding process. Failure is indicated with an F-Code on the display of the tool.

---

Figure 3.8-1: Active Fusion Indicator (AFI)

## 4 F-BT STUD DESCRIPTION

### 4.1 Stud designation

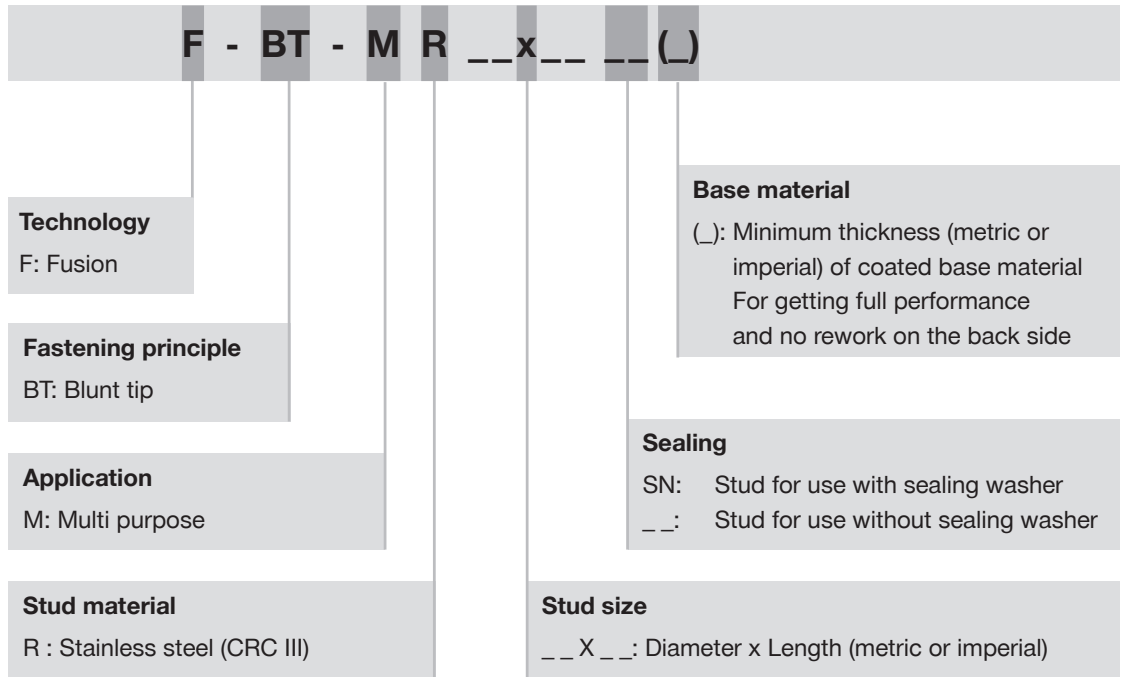

## 4.2 Stud design principles

Stud design includes a centering and ignition tip and an interface holder to ensure correct stud positioning and proper stud fusion.

---

### Centering and ignition tip

---

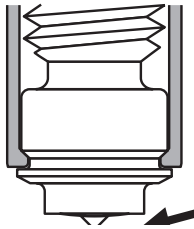

- Centering tip required for positioning
- Ignition tip required for arc striking

Figure 4.2-1: Centering and ignition tip

The stud feeding system consists mainly of a specialized stud holder interface as part of the hand tool. This interface ensures the mechanical and the electrical interlock. The stud connection at the stud front allows the use for different stud lengths with the same stud holder interface. Figure 4.2-2 shows the stud holder interface as part of the stud feeding system.

---

### Stud holder interface

---

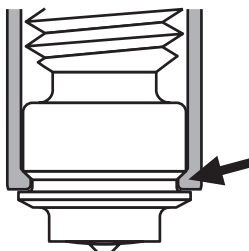

- Provides mechanical and electrical interlock
- Front connection allows use of different stud lengths
- Interface integrated in the hand tool

Figure 4.2-2: Stud holder interface

The sealing washer protects the parent material against corrosion. The sealing washer grips the stud at the sealing washer interface.

---

### Sealing washer interface

---

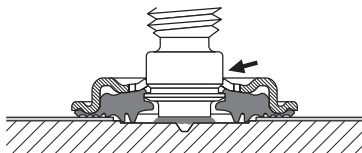

- Provides a clamping lock between stud and sealing washer

Figure 4.2-3: Sealing washer interface

### 4.3 Stud recommendation

Stud with sealing washer for fastening on coated material	Stud without sealing washer for fastening on coated and uncoated material
F-BT-MR SN	F-BT-MR
Metric sizes: M6, M8, M10, M12	Metric sizes: M6, M8, M10, M12
Imperial sizes: 3/8"	Imperial sizes: 3/8", 1/2"
Sealing through washer	Sealing through painting

Figure 4.3-1: Stud recommendation

#### Stainless steel studs F-BT-MR SN with sealing washer for thin parent material

Parent material	Coated material, reduced parent material thickness $t_{II} = 4 \text{ mm}$		
Model sketch			
$L_{\text{thread length}}$	25 mm	25 mm	1"
Designation	F-BT-MR M6x25 SN (4)	F-BT-MR M8x25 SN (4)	F-BT-MR 3/8x1 SN (5/32)

Figure 4.3-2: Stainless steel studs F-BT-MR SN with sealing washer for thin parent material

### Stainless steel studs F-BT-MR SN with sealing washer

Parent material	Coated material, standard parent material thickness $t_{II}$				
Model sketch					
$L_{\text{thread length}}$	25 mm	25 mm	25 and 50 mm	1, 1-1/2, 2 and 4"	25 and 50 mm
Designation	F-BT-MR M6x25 SN (6)	F-BT-MR M8x25 SN (8)	F-BT-MR M10x25 SN (10) F-BT-MR M10x50 SN (10)	F-BT-MR 3/8x1 SN (3/8) F-BT-MR 3/8x1-1/2 SN (3/8) F-BT-MR 3/8x2 SN (3/8) F-BT-MR 3/8x4 SN (3/8)	F-BT-MR M12x25 SN (10) F-BT-MR M12x50 SN (10)

Figure 4.3-3: Stainless steel studs F-BT-MR SN with sealing washer

### Stainless steel studs F-BT-MR without sealing washer

Parent material	Coated and uncoated material, standard parent material thickness $t_{II}$					
Model sketch						
$L_{\text{thread length}}$	25 mm	25 mm	25 and 50 mm	1, 1-1/2, 2 and 4"	25 and 50 mm	1-1/2 and 2"
Designation	F-BT-MR M6x25 (6)	F-BT-MR M8x25 (8)	F-BT-MR M10x25 (10) F-BT-MR M10x50 (10)	F-BT-MR 3/8x1 (3/8) F-BT-MR 3/8x1-1/2 (3/8) F-BT-MR 3/8x2 (3/8) F-BT-MR 3/8x4 (3/8)	F-BT-MR M12x25 (10) F-BT-MR M12x50 (10)	F-BT-MR 1/2x1-1/2 (3/8) F-BT-MR 1/2x2 (3/8)

Figure 4.3-4: Stainless steel studs F-BT-MR without sealing washer

## 4.4 Corrosion resistance and durability through sealing

The corrosion resistance and durability in highly corrosive environment must be taken into account in the design. The correct sealing washer installation is the best way to avoid corrosion. In order to ensure a reliable connection between stud and sealing washer a sealing washer interface has been designed.

Corrosion resistance is defined as the ability to protect the substrate from corrosion. The following methods or treatments are applied to resist corrosion:

- Sealing through sealing washer
- Sealing through painting

### Sealing through sealing washer

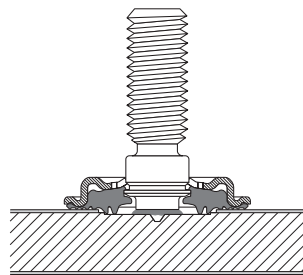

The sealing washer helps to protect the base material and the welded area against corrosion. It consists of a chloroprene rubber bonded to a specially formed stainless steel washer. The sealing washer creates a heavy duty and durable sealing solution for studs.

Temperature range in service	-40°C to 60°C
Sealing washer water tightness	56d salt spray test according to EN ISO 9227
Sealing washer resistant to	UV, salt water, water ozone, oils, etc.

Based on comprehensive corrosion and durability tests performed in the laboratory, a minimum service life of 20 years can be assumed.

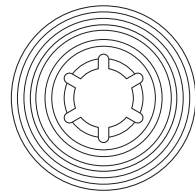

#### Washer cap

- Stainless steel
- Metallic carrier for the elastomer material
- Clamps elastomer against the stud
- Ensures correct positioning of the sealing washer
- Compression resistant

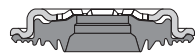

#### Sealing material

- Chloroprene rubber (CR)



• For more details, please refer to the Instruction for Use (IFU).

Figure 4.4-1: Sealing through sealing washer

### Sealing through painting

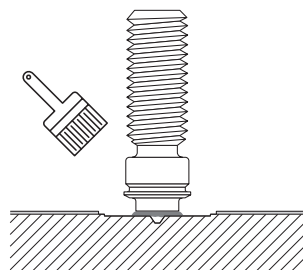

- Painting is an alternative to the use of sealing washers.
- Corrosion resistance and durability through painting is not subject of this document.
- Sealing through painting provided by manufacturer.

Figure 4.4-2: Sealing through painting

## 4.5 Requirements for corrosion protection

In order to meet the respective requirements for corrosion protection, the expected level of exposure to corrosion for the fastening point must be reviewed beforehand. For example, the exposure to corrosion is much higher in environments with seawater than in other areas. Figure 4.5-1 shows a selection of studs for different environmental conditions.

Both the F-BT-MR SN and F-BT-MR fasteners are made of 1.4571 (A5, 316Ti) stainless steel, a Corrosion resistance class 3 (CRC III) material, which provides a level of corrosion protection for the fasteners. Due to the unique installation involving surface preparation and welding, it is important to provide additional sealing method for corrosion protection of the prepared surface and weld areas.

Figure 4.5-1 shows a selection of studs and their corresponding sealing methods for different environmental conditions.

Environmental condition	Fastened part	Stud with sealing washer for fastening on coated material	Stud without sealing washer for fastening on coated material
		Sealing through washer	Sealing through painting
		F-BT-MR SN	F-BT-MR
Dry indoor	zinc-coated steel, painted steel, aluminum, stainless steel	■	■
Indoor with temporary condensation		■	■
Outdoor with low pollution		■	■
Outdoor with moderate concentration of pollutants 1-10 km		■	■
Coastal areas 0-1km		■	■
Outdoor, areas with heavy industrial pollution		■	■

■ Recommended solution for corrosion protection when installed according to IFU.

■ May be suitable for corrosion protection with appropriate coating and sealing of the weld zone. Paint provided by others.



• For more details, please refer to following technical document: Hilti Corrosion Handbook.

Figure 4.5.1: Selection of studs for different environmental conditions

## 4.6 Structural load types

Load direction types can be classified into five groups: tension load, compression load, shear load, bending moment and load interaction. These load types are shown in Figure 4.6.1.

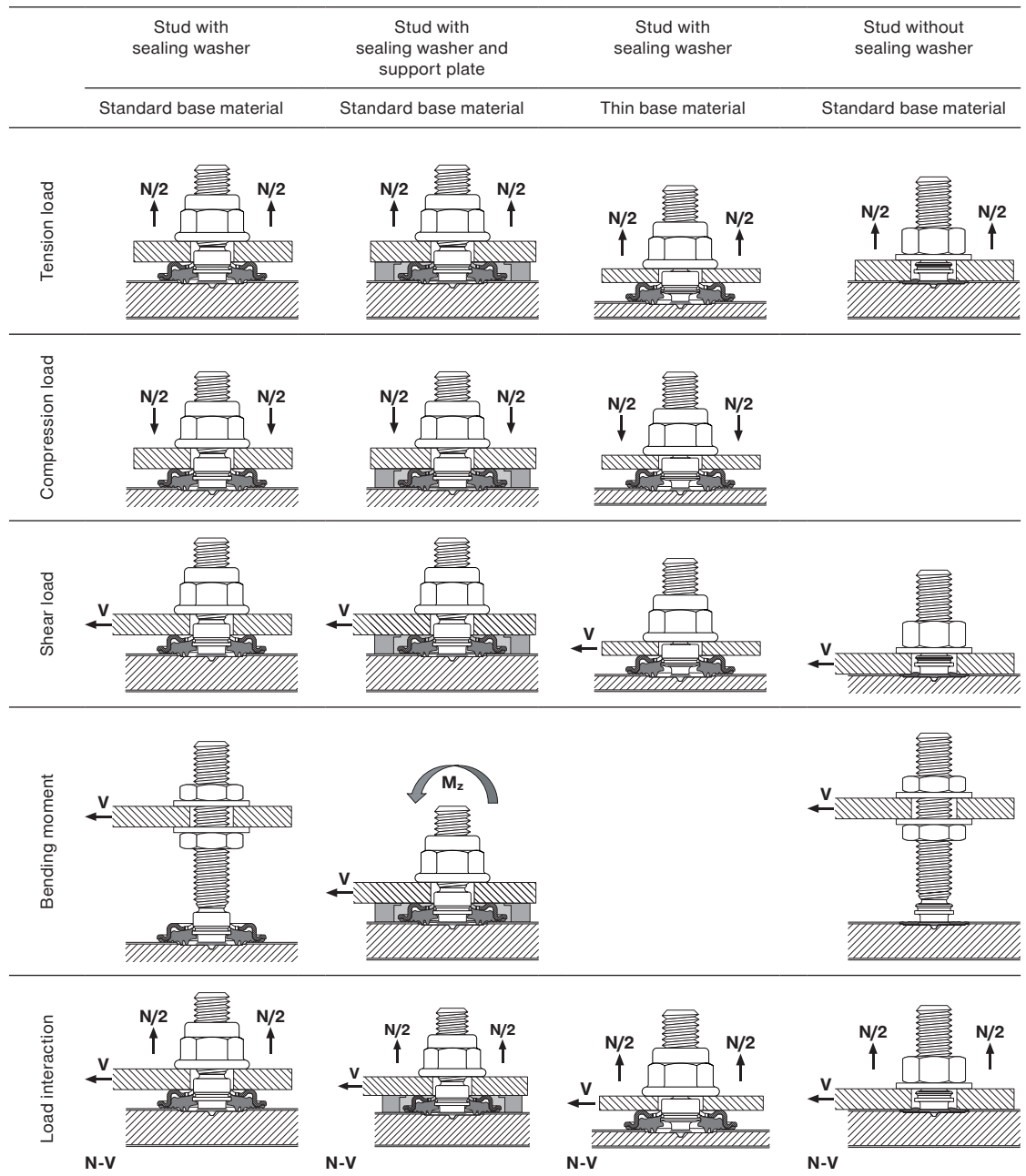

Figure 4.6-1: Load direction types



## 5 TECHNICAL DATA FOR F-BT-MR SN

### 5.1 Stud specification

#### Stud dimensions

	L L <sub>1</sub> d <sub>1</sub> d <sub>2</sub> d <sub>h1</sub> d <sub>h2</sub> d <sub>n</sub>			Thread length Nominal stud length Nominal diameter, thread diameter Diameter of weld area Diameter of sealing washer interface Diameter of stud holder interface Diameter of necking area of stud			
	Designation	L	L <sub>1</sub>	d <sub>1</sub>	d <sub>2</sub>	d <sub>h1</sub>	d <sub>h2</sub>
Metric size							
F-BT-MR M6x25 SN (4)	25 mm	34 mm	M6	5 mm	7 mm	7.6 mm	4 mm
F-BT-MR M8x25 SN (4)	25 mm	34 mm	M8	5 mm	8.6 mm	9.2 mm	4 mm
F-BT-MR M6x25 SN (6)	25 mm	34 mm	M6	5 mm	7 mm	7.6 mm	4.4 mm
F-BT-MR M8x25 SN (8)	25 mm	34 mm	M8	6 mm	8.6 mm	9.2 mm	6 mm
F-BT-MR M10x25 SN (10)	25 mm	34 mm	M10	7.2 mm	10.6 mm	11.2 mm	6.8 mm
F-BT-MR M10x50 SN (10)	50 mm	59 mm	M10	7.2 mm	10.6 mm	11.2 mm	6.8 mm
F-BT-MR M12x25 SN (10)	25 mm	34 mm	M12	7.2 mm	13.4 mm	14 mm	6.8 mm
F-BT-MR M12x50 SN (10)	50 mm	59 mm	M12	7.2 mm	13.4 mm	14 mm	6.8 mm
Imperial size							
F-BT-MR 3/8x1 SN (5/32)	1"	1.323"/ 34 mm	3/8"	0.197"/ 5 mm	0.417"/ 10.6 mm	0.441"/ 11.2 mm	0.157"/ 4 mm
F-BT-MR 3/8x1 SN (3/8)	1"	1.323"/ 34 mm	3/8"	0.283"/ 7.2 mm	0.417"/ 10.6 mm	0.441"/ 11.2 mm	0.268"/ 6.8 mm
F-BT-MR 3/8x1 1/2 SN (3/8)	1 1/2"	1.838"/ 47 mm	3/8"	0.283"/ 7.2 mm	0.417"/ 10.6 mm	0.441"/ 11.2 mm	0.268"/ 6.8 mm
F-BT-MR 3/8x2 SN (3/8)	2"	2.339"/ 59 mm	3/8"	0.283"/ 7.2 mm	0.417"/ 10.6 mm	0.441"/ 11.2 mm	0.268"/ 6.8 mm
F-BT-MR 3/8x4 SN (3/8)	4"	4.213"/ 107 mm	3/8"	0.283"/ 7.2 mm	0.417"/ 10.6 mm	0.441"/ 11.2 mm	0.268"/ 6.8 mm

Table 5.1-1: Stud dimensions

#### Stud material specification and material properties for stainless steel parts

Designation	Element	Material	Steel grade	Standard	Corrosion resistance class	Corrosion resistance standard
F-BT-MR SN	Stud	Stainless steel	1.4571 (A5)	EN 10088-3	CRC III	EN 1993-1-4
			316Ti	ASTM A240/A276	-	-

Table 5.1-2: Stud material specification and material properties for stainless steel parts

### Sealing washer dimensions

	Sealing washer outer diameter D	Sealing washer inner diameter d	Compatibility	
			Stud	Sealing washer setting tool /Adapter size
	Metric size			
	31.5 mm	6.1 mm	F-BT-MR M6xL SN	X-WST F3-BT (M6-1/4")
	31.5 mm	7.4 mm	F-BT-MR M8xL SN	X-WST F3-BT (M8-5/16")
	31.5 mm	9.2 mm	F-BT-MR M10xL SN	X-WST F3-BT (M10-3/8")
	35.1 mm	12.2 mm	F-BT-MR M12xL SN	X-WST F3-BT (M12-1/2")
	Imperial size			
	1.24"/31.5 mm	0.362"/9.2 mm	F-BT-MR 3/8"xL SN	X-WST F3-BT (M10-3/8")

Figure 5.1-3: Sealing washer dimensions

### Sealing washer material specification and material properties

Designation	Element	Material	Steel grade	Standard	Corrosion resistance class	Corrosion resistance standard
Sealing ring	Metal cap	Stainless steel	1.4404 (A4)	EN 10088-2	CRC III	EN 1993-1-4
		Stainless steel	316L	ASTM A240	-	-
Sealing ring	Sealing elastomer	chloroprene rubber (CR)				

Table 5.1-4: Sealing washer material specification and material properties

### Flange lock nut dimensions

Metric size

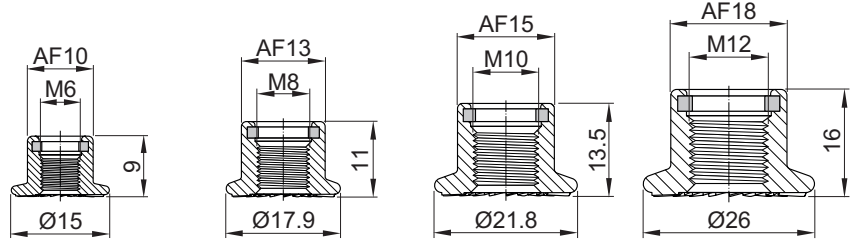

Imperial size

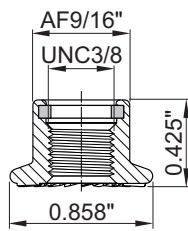

• F-BT-MR SN shall only be used with the provided flange lock nut.

Figure 5.1-5: Flange lock nut dimensions

### Support plate dimensions

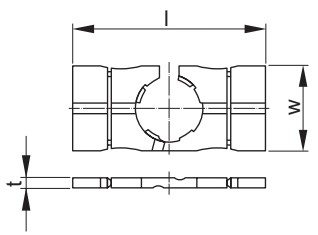

Designation	Length l	Width w	Thickness t
FX 3-SP S	100 mm	44 mm	5.5 mm
FX 3-SP L	100 mm	47 mm	5.5 mm

Figure 5.1-6: Support plate dimensions

### Support plate material specification

Designation	Element	Material
FX 3-SP S	Support plate	PA66-GF50
FX 3-SP L	Support plate	PA66-GF50

Table 5.1-7: Support plate material specification

## 5.2 Application recommendation

### 5.2.1 Application area

#### Intended use

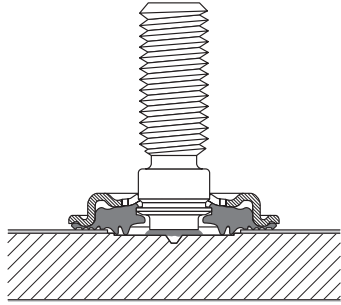

- For multiple fastening of non-structural components
- For fastening on coated unalloyed carbon steel for use in marine atmospheres
- Conditions during installation:
  - surface to be welded shall be maintained dry and free from condensation
  - temperature of stud and base material temperature:  $> 0^{\circ}\text{C}$  ( $32^{\circ}\text{F}$ )
- Service temperatures  $-40^{\circ}\text{C}$  to  $60^{\circ}\text{C}$  ( $-40^{\circ}\text{F}$  to  $140^{\circ}\text{F}$ )
- Corrosion resistance class CRC III according to EN 1993-1-4
- Water tightness validated by means of 56 days salt spray test according to EN ISO 9227.
- Based on comprehensive corrosion and durability tests performed in the laboratory, a minimum service life of 20 years can be assumed.

Figure 5.2.1-1: Intended use

### 5.2.2 Fastened material

#### Fastened material properties

Designation	Fastened material thickness		Hole tolerance	
	$t_{l,\min}$	$t_{l,\max}$	$d_{f,\min}$	$d_{f,\max}$
Metric size				
F-BT-MR M6x25 SN (4)	3.5 mm	10 mm	8 mm	9.5 mm
F-BT-MR M8x25 SN (4)		10 mm	9.5 mm	12 mm
F-BT-MR M6x25 SN (6)		10 mm	8 mm	9.5 mm
F-BT-MR M8x25 SN (8)		10 mm	9.5 mm	12 mm
F-BT-MR M10x25 SN (10)		10 mm	12 mm	15 mm
F-BT-MR M10x50 SN (10)		20 mm	12 mm	15 mm
F-BT-MR M12x25 SN (10)		10 mm	15 mm	18.5 mm
F-BT-MR M12x50 SN (10)		20 mm	15 mm	18.5 mm
Imperial size				
F-BT-MR 3/8x1 SN (5/32)	1/8" 3.5 mm	3/8" / 10 mm	0.472" 12 mm	0.571" 14.5 mm
F-BT-MR 3/8x1 SN (3/8)		3/8" / 10 mm		
F-BT-MR 3/8x1 1/2 SN (3/8)		3/4" / 20 mm		
F-BT-MR 3/8x2 SN (3/8)		3/4" / 20 mm		
F-BT-MR 3/8x4 SN (3/8)		3/4" / 20 mm		



• minimum fastened material thickness  $t_{l,\min}$  can be achieved by use of multiple layers.

Table 5.2.2-2: Fastened material properties

### 5.2.3 Parent material

#### Parent material specification

##### Subgroup 1.1, 1.2 according to CEN ISO/TR 15608

Standard/ application area	Steel grade
EN 10025-2	S235JR +N (or +AR) to S355K2 +N (or +AR)
EN 10025-3	S275N/NL to S355N/NL
ASTM	ASTM A36, ASTM 572 Grade 50
Shipbuilding steel	A, B, D, E, AH 32, DH 32, AH 36, DH 36, EH 36
Carbon equivalent value: CEV ≤ 0.45	$CEV=C + \frac{Mn}{6} + \frac{Cr+Mo+V}{5} + \frac{Ni+Cu}{15}$

**Table 5.2.3-1 Parent material specification**

#### Parent material properties

	$t_{l,min}$	$t_{l,max}$
Metric size		
F-BT-MR M6xL SN (4)	4 mm	30 mm
F-BT-MR M8xL SN (4)		
F-BT-MR M6xL SN (6)	6 mm	30 mm
F-BT-MR M8xL SN (8)	8 mm	30 mm
F-BT-MR M10xL SN (10)	10 mm	30 mm
F-BT-MR M12xL SN (10)		
Imperial size		
F-BT-MR 3/8xL SN (5/32)	5/32"/ 4 mm	1 1/8"/ 30 mm
F-BT-MR 3/8xL SN (3/8)	3/8"/ 10 mm	1 1/8"/ 30 mm

**Table 5.2.3-2: Parent material properties**

#### Parent material shape

Admissible parent material shapes	Flat steel, curved steel with $R \geq 600$ mm
-----------------------------------	---

**Table 5.2.3-3: Parent material shape**

### Stud positioning in parent material

Designation	Spacing between studs $s_{min}$	Edge distance $c_{min}$
Metric size		
F-BT-MR M6xL SN (4)	35 mm	38 mm
F-BT-MR M8xL SN (4)		
F-BT-MR M6xL SN (6)		
F-BT-MR M8xL SN (8)		
F-BT-MR M10xL SN (10)		
F-BT-MR M12xL SN (10)		
Imperial size		
F-BT-MR 3/8xL SN (5/32)	1 3/8" / 35 mm	1 1/2" / 38 mm
F-BT-MR 3/8xL SN (3/8)		

**Table 5.2.3-4: Stud positioning in parent material**

## 5.3 Performance data

In the design of steel structures or vessels, safety factors are applied to account for the uncertainty in applied loads and to provide a margin of safety against failure, and to keep deformations within acceptable limits. Most designs are based on the partial factor method or the working load concept.

Therefore, this section will concentrate on the presentation of the design resistance (partial factor method) and recommended loads (working load concept).

### Design resistance under tension load, shear load and bending moment based on partial factor method

Designation	Parent material thickness $t_{II}$	Tension load $N_{Rd}$	Compression load $N_{Rd}$	Shear load $V_{Rd}$	Bending moment $M_{Rd}$
Metric size					
F-BT-MR M6xL SN (4)	$4 \leq t_{II} < 30$ mm	2.5 kN	11.2 kN	1.4 kN	n. a.
F-BT-MR M8xL SN (4)	$4 \leq t_{II} < 30$ mm	2.5 kN	11.2 kN	1.4 kN	
F-BT-MR M6xL SN (6)	$6 \leq t_{II} < 30$ mm	4.3 kN	11.2 kN	1.9 kN	
F-BT-MR M8xL SN (8)	$8 \leq t_{II} < 30$ mm	6.3 kN	11.2 kN	2.8 kN	
F-BT-MR M10xL SN (10)	$10 \leq t_{II} < 30$ mm	11.2 kN	11.2 kN	5 kN	28 Nm
F-BT-MR M12xL SN (10)	$10 \leq t_{II} < 30$ mm	11.2 kN	11.2 kN	5 kN	28 Nm
Imperial size					
F-BT-MR 3/8xL SN (5/32)	$5/32" \leq t_{II} < 1 1/8" / 4 \leq t_{II} < 30$ mm	560 lb / 2.5 kN	2520 lb / 11.2 kN	315 lb / 1.4 kN	n. a.
F-BT-MR 3/8xL SN (3/8)	$3/8" \leq t_{II} < 1 1/8" / 10 \leq t_{II} < 30$ mm	2520 lb / 11.2 kN	2520 lb / 11.2 kN	1125 lb / 5 kN	20.6 lb-ft / 28 Nm

**Table 5.3-1: Design resistance under tension load, shear load and bending moment based on partial factor method**

**Recommended tension load, shear load and bending moment based on working load concept**

Designation	Parent material thickness $t_{II}$	Tension load $N_{rec}$	Compression load $N_{rec}$	Shear load $V_{rec}$	Bending moment $M_{rec,z}$
Metric size					
F-BT-MR M6xL SN (4)	$4 \leq t_{II} < 30$ mm	1.8 kN	8.0 kN	1.0 kN	n. a.
F-BT-MR M8xL SN (4)	$4 \leq t_{II} < 30$ mm	1.8 kN	8.0 kN	1.0 kN	
F-BT-MR M6xL SN (6)	$6 \leq t_{II} < 30$ mm	3.1 kN	8.0 kN	1.4 kN	
F-BT-MR M8xL SN (8)	$8 \leq t_{II} < 30$ mm	4.5 kN	8.0 kN	2.0 kN	
F-BT-MR M10xL SN (10)	$10 \leq t_{II} < 30$ mm	8.0 kN	8.0 kN	3.6 kN	20 Nm
F-BT-MR M12xL SN (10)	$10 \leq t_{II} < 30$ mm	8.0 kN	8.0 kN	3.6 kN	20 Nm
Imperial size					
F-BT-MR 3/8xL SN (5/32)	$5/32'' \leq t_{II} < 1\ 1/8''$ / $4 \leq t_{II} < 30$ mm	405 lb/ 1.8 kN	1800 lb/ 8.0 kN	225 lb/ 1.0 kN	n. a.
F-BT-MR 3/8xL SN (3/8)	$3/8'' \leq t_{II} < 1\ 1/8''$ / $10 \leq t_{II} < 30$ mm	1800 lb/ 8.0 kN	1800 lb/ 8.0 kN	810 lb/ 3.6 kN	14.7 lb-ft/ 20 Nm

**Table 5.3-2: Recommended tension load, shear load and bending moment based on working load concept**

**Group fastenings**

Group behaviour is affected by stud ductility and actual clearance. In order to cover unfavorable position of studs in rows or rectangular plates, the following rule applies:

	<p>Studs in rows:</p> <ul style="list-style-type: none"> <li>One stud of a row of n (here: n = 4) studs is considered for the total shear load of the row.</li> </ul>
	<p>Studs in rectangular plates:</p> <ul style="list-style-type: none"> <li>Rectangular plate with 4 studs in the corner and shear load introduction in center of plate.</li> <li>Two studs of a group of four studs are considered for the total shear load of the group.</li> </ul>

**Figure 5.3-3: Group fastenings**

### Bending moment for fastening multi-duty channel system (MT)

Multi-duty channel system (MT)	MT-B-T MT-B-T OC	MT-B-02 MT-B-02-OC	MT-B-02B MT-B-02B OC	MT-BR-40 MT-BR-40 OC
	2-hole base plate			Cantilever arm
Multi-duty channel width	42 mm	83 mm	100 mm	60 mm
Support plate	FX 3-SP S	FX 3-SP S	FX 3-SP S	FX 3-SP S
Stud	F-BT-MR M10xL SN (10)	F-BT-MR M10xL SN (10)	F-BT-MR M10xL SN (10)	F-BT-MR M10xL SN (10)
Design bending moment $M_{z,Rd}$	52.8 Nm	232.8 Nm	357.6 Nm	790.0 Nm
Recommended bending moment $M_{z,rec}$	37.7 Nm	166.3 Nm	255.4 Nm	565.0 Nm

- 2-hole base plate and cantilever arm are intended to be used with support plate.
- For the design of the stud linear N-V- $M_z$  interaction applies (with  $M_z$  referring to the utilization of the 2-hole base plate).
- Design and recommended bending moments for generic cases of 2-hole base plates, varying stud sizes, plate width and thickness will be published in the upcoming release of this Manual.

Figure 5.3-4: Bending moment for fastening multi-duty channel system (MT)

Figure 5.3-5 shows an installation example for 2-hole base plate.

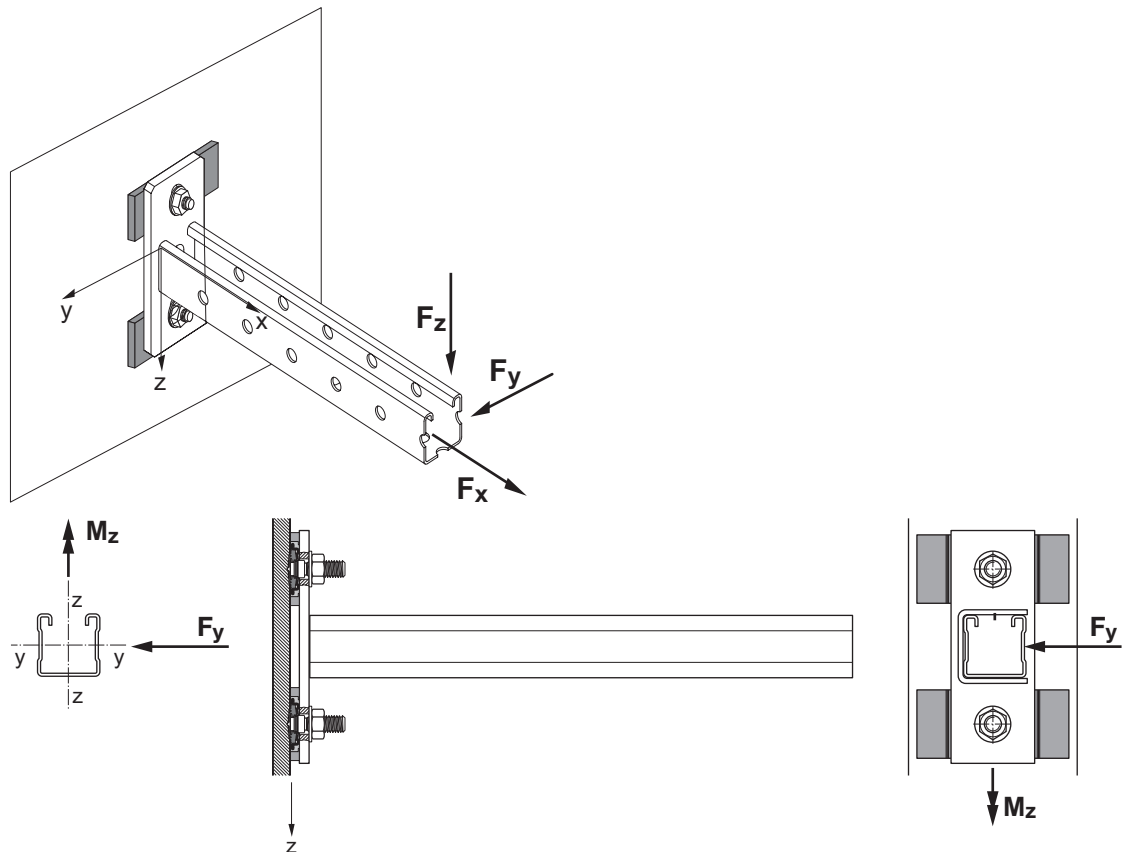

Figure 5.3-5: Installation example for 2-hole base plate



## 5.4 Installation recommendations

### 5.4.1 Stud installation

The following guidelines provide the specifications for CSF stud installation. Typically installation will be performed in accordance with a welding code/standard such as EN ISO 14555 or AWS D1.6, which have additional requirements in regards to installation. Please see section 8 for more information regarding processes in keeping with EN ISO 14555.

### 5.4.2 Sealing washer installation inspection

#### Sealing washer inspection

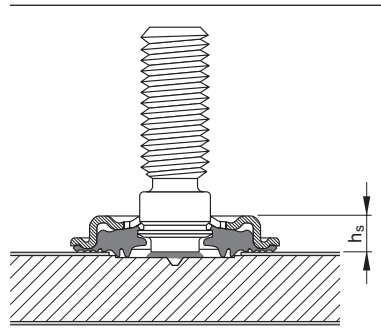

Height between washer surface and coating surface  $h_s$  shall be checked with washer check gauge X-WCG F3-BT.



• For more details, please refer to the following technical document: instruction for Use (IFU).

Figure 5.4.2-1: Sealing washer inspection

### 5.4.3 Installation torque

#### Installation torque

Designation	Torque moment $T_{inst}$	Nut type to be used	Tightening tool
Metric size			
F-BT-MR M8xL SN (4)	6 Nm	Flange lock nut	Tightening tools with torque control function
F-BT-MR M8xL SN (4)	6 Nm	Flange lock nut	
F-BT-MR M6xL SN (6)	8 Nm	Flange lock nut	
F-BT-MR M8xL SN (8)	20 Nm	Flange lock nut	
F-BT-MR M10xL SN (10)	30 Nm	Flange lock nut	
F-BT-MR M12xL SN (10)	30 Nm	Flange lock nut	
Imperial size			
F-BT-MR 3/8xL SN (5/32)	4.4 lb-ft/6 Nm	Flange lock nut	Tightening tools with torque control function
F-BT-MR 3/8xL SN (3/8)	22.1 lb-ft/30 Nm	Flange lock nut	



- F-BT-MR SN shall only be used with the provided flange lock-nut.
- For more details, please refer to the instructions for use (IFU).
- A powered tightening tool shall not be used.

Table 5.4.3-1: Installation torque

## 6 TECHNICAL DATA FOR F-BT-MR

### 6.1 Stud specification

#### Stud dimensions

	L L <sub>1</sub> d <sub>1</sub> d <sub>2</sub> d <sub>h1</sub> d <sub>h2</sub> d <sub>n</sub>			Thread length Nominal stud length Nominal diameter, thread diameter Diameter of weld area Diameter of stud area Diameter of stud holder interface Diameter of necking area of stud			
	Designation	L	L <sub>1</sub>	d <sub>1</sub>	d <sub>2</sub>	d <sub>h1</sub>	d <sub>h2</sub>
Metric size							
F-BT-MR M6x25 (6)	25 mm	30 mm	M6	5 mm	7 mm	7.6 mm	4.4 mm
F-BT-MR M8x25 (8)	25 mm	30 mm	M8	6 mm	8.6 mm	9.2 mm	6 mm
F-BT-MR M10x25 (10)	25 mm	30 mm	M10	7.2 mm	10.6 mm	11.2 mm	6.8 mm
F-BT-MR M10x50 (10)	50 mm	55 mm	M10	7.2 mm	10.6 mm	11.2 mm	6.8 mm
F-BT-MR M12x25 (10)	25 mm	30 mm	M12	7.2 mm	13.4 mm	14 mm	6.8 mm
F-BT-MR M12x50 (10)	50 mm	55 mm	M12	7.2 mm	13.4 mm	14 mm	6.8 mm
Imperial size							
F-BT-MR 3/8x1 (3/8)	1"	1.220"/ 31 mm	3/8"	0.283"/ 7.2 mm	0.417"/ 10.6 mm	0.441"/ 11.2 mm	0.268"/ 6.8 mm
F-BT-MR 3/8x1 1/2 (3/8)	1 1/2"	1.693"/ 43 mm	3/8"	0.283"/ 7.2 mm	0.417"/ 10.6 mm	0.441"/ 11.2 mm	0.268"/ 6.8 mm
F-BT-MR 3/8"x2 (3/8)	2"	2.205"/ 56 mm	3/8"	0.283"/ 7.2 mm	0.417"/ 10.6 mm	0.441"/ 11.2 mm	0.268"/ 6.8 mm
F-BT-MR 3/8x4 (3/8)	4"	4.213"/ 107 mm	3/8"	0.283"/ 7.2 mm	0.417"/ 10.6 mm	0.441"/ 11.2 mm	0.268"/ 6.8 mm
F-BT-MR 1/2x1 1/2 (3/8)	1 1/2"	1.693"/ 43 mm	1/2"	0.283"/ 7.2 mm	0.528"/ 13.4 mm	0.441"/ 14 mm	0.268"/ 6.8 mm
F-BT-MR 1/2x2 (3/8)	2"	2.205"/ 56 mm	1/2"	0.283"/ 7.2 mm	0.528"/ 13.4 mm	0.441"/ 14 mm	0.268"/ 6.8 mm

Table 6.1-1 Stud dimensions

#### Stud material specification

Designation	Element	Material	Steel grade	Standard	Corrosion resistance class	Corrosion resistance standard
F-BT-MR	Stud	Stainless steel	1.4571 (A5)	EN 10088-3	CRC III	EN 1993-1-4
			316Ti	ASTM A240/A276	-	-

Table 6.1-2 Stud material specification

## 6.2 Application recommendation

### 6.2.1 Application area

#### Intended use

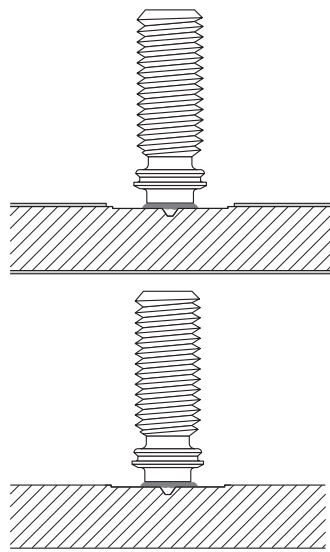

- For multiple fastening of non-structural components
- For fastening on coated and un-coated unalloyed carbon steel for use in marine atmospheres
- Conditions during installation:
  - Surface to be welded shall be maintained dry and free from condensation
  - Temperature of stud and base material temperature:  $> 0^{\circ}\text{C}$  ( $32^{\circ}\text{F}$ )
- Service temperatures  $-40^{\circ}\text{C}$  to  $60^{\circ}\text{C}$  ( $-40^{\circ}\text{F}$  to  $140^{\circ}\text{F}$ )

Figure 6.2.1-1 Intended use

### 6.2.2 Fastened material

#### Fastened material properties

Designation	Fastened material thickness		Hole tolerance	
	$t_{l,min}$	$t_{l,max}$	$d_{f,min}$	$d_{f,max}$
Metric size				
F-BT-MR M6x25 (6)	4.5 mm	10 mm	8.5 mm	10 mm
F-BT-MR M8x25 (8)		10 mm	10 mm	12.5 mm
F-BT-MR M10x25 (10)		10 mm	12.5 mm	15.5 mm
F-BT-MR M10x50 (10)		20 mm	12.5 mm	15.5 mm
F-BT-MR M12x25 (10)		10 mm	15.5 mm	19 mm
F-BT-MR M12x50 (10)		20 mm	15.5 mm	19 mm
Imperial size				
F-BT-MR 3/8x1 (3/8)	3/16" / 4.5 mm	3/8" / 10 mm	0.492" / 12.5 mm	0.591" / 15 mm
F-BT-MR 3/8x1 1/2 (3/8)		3/4" / 20 mm		
F-BT-MR 3/8x2 (3/8)		3/4" / 20 mm		
F-BT-MR 3/8x4 (3/8)		3/4" / 20 mm	0.591" / 15 mm	0.768" / 19.5 mm
F-BT-MR 1/2x1 1/2 (3/8)		3/4" / 20 mm		
F-BT-MR 1/2x2 (3/8)		3/4" / 20 mm		

• Fastened material thickness  $t_{l,min}$  can be achieved by use of multiple layers.

Table 6.2.2-1: Fastened material properties

## 6.2.3 Parent material

### Parent material specification: subgroup 1.1, 1.2 according to CEN ISO/TR 15608

Standard/application area	Steel grade
EN 10025-2	S235JR +N (or +AR) to S355K2 +N (or +AR)
EN 10025-3	S275N/NL to S355N/NL
ASTM	ASTM A36, ASTM 572 Grade 50
Shipbuilding steel	A, B, D, E, AH 32, DH 32, AH 36, DH 36, EH 36
Carbon equivalent value: CEV ≤ 0.45	$CEV = C + \frac{Mn}{6} + \frac{Cr+Mo+V}{5} + \frac{Ni+Cu}{15}$

**Table 6.2.3-1: Parent material specification**

### Parent material properties

Designation	Parent material thickness			
	$t_{II,min}$	$t_{II,max}$	$t_{II,min}$	$t_{II,max}$
	(for uncoated parent steel)		(for coated parent steel)	
Metric size				
F-BT-MR M6xL (6)	2 mm	30 mm	6 mm	30 mm
F-BT-MR M8xL (8)	2 mm	30 mm	8 mm	30 mm
F-BT-MR M10xL (10)	2 mm	30 mm	10 mm	30 mm
F-BT-MR M12xL (10)	2 mm	30 mm	10 mm	30 mm
Imperial size				
F-BT-MR 3/8xL (3/8)	0.0787"/ 2 mm	1 1/8"/ 30 mm	3/8"/ 10 mm	1 1/8"/ 30 mm
F-BT-MR 1/2xL (3/8)	0.0787"/ 2 mm	1 1/8"/ 30 mm	3/8"/ 10 mm	1 1/8"/ 30 mm

**Table 6.2.3-2: Parent material properties**

### Parent material shape

Admissible parent material shapes	Flat steel, curved steel with $R \geq 600$ mm
-----------------------------------	---

**Table 6.2.3-3: Parent material shape**

### Stud positioning in parent material

Designation	Spacing between studs $s_{min}$	Edge distance $c_{min}$
Metric size		
F-BT-MR M6xL (6)	35 mm	38 mm
F-BT-MR M8xL (8)		
F-BT-MR M10xL (10)		
F-BT-MR M12xL (10)		
Imperial size		
F-BT-MR 3/8xL (3/8)	1 3/8"/ 35 mm	1 1/2"/ 38 mm
F-BT-MR 1/2xL (3/8)		

**Table 6.2.3-4: Stud positioning in parent material**

### 6.3 Performance data

In design of steel structures or vessels, safety factors are applied to account for the uncertainty in applied loads and to provide a margin of safety against failure, and to keep deformations within acceptable limits. Most designs are based on the partial factor method or the working load concept.

Therefore, this section will concentrate on the presentation of the design resistance (partial factor method) and the recommended loads (working load concept).

#### Design resistance under tension load, shear load and bending moment based on partial factor method

Designation	Parent material thickness $t_{II}$	Tension load $N_{Rd}$	Shear load $V_{Rd}$	Bending moment $M_{Rd}$
Metric size				
F-BT-MR M6xL (6)	$6 \leq t_{II} < 30$ mm	4.3 kN	2.5 kN	n. a.
F-BT-MR M8xL (8)	$8 \leq t_{II} < 30$ mm	6.3 kN	3.6 kN	
F-BT-MR M10xL (10)	$10 \leq t_{II} < 30$ mm	11.2 kN	6.3 kN	28 Nm
F-BT-MR M12xL (10)	$10 \leq t_{II} < 30$ mm	11.2 kN	6.3 kN	28 Nm
Imperial size				
F-BT-MR 3/8xL (3/8)	$3/8" \leq t_{II} < 1 1/8"$ $10 \leq t_{II} < 30$ mm	2520 lb/ 11.2 kN	1415 lb/ 6.3 kN	20.6 lb-ft/ 28 Nm
F-BT-MR 1/2xL (3/8)	$3/8" \leq t_{II} < 1 1/8"$ $10 \leq t_{II} < 30$ mm	2520 lb/ 11.2 kN	1415 lb/ 6.3 kN	20.6 lb-ft/ 28 Nm

**Table 6.3-1: Design resistance under tension load, shear load and bending moment based on partial factor method**

#### Recommended tension load, shear load and bending moment based on working load concept

Designation	Parent material thickness $t_{II}$	Tension load $N_{rec}$	Shear load $V_{rec}$	Bending moment $M_{rec}$
Metric size				
F-BT-MR M6xL (6)	$6 \leq t_{II} < 30$ mm	3.1 kN	1.8 kN	n. a.
F-BT-MR M8xL (8)	$8 \leq t_{II} < 30$ mm	4.5 kN	2.6 kN	
F-BT-MR M10xL (10)	$10 \leq t_{II} < 30$ mm	8.0 kN	4.5 kN	20 Nm
F-BT-MR M12xL (10)	$10 \leq t_{II} < 30$ mm	8.0 kN	4.5 kN	20 Nm
Imperial size				
F-BT-MR 3/8xL (3/8)	$3/8" \leq t_{II} < 1 1/8"$ $10 \leq t_{II} < 30$ mm	1800 lb/ 8.0 kN	1010 lb/ 4.5 kN	14.7 lb-ft/ 20 Nm
F-BT-MR 1/2xL (3/8)	$3/8" \leq t_{II} < 1 1/8"$ $10 \leq t_{II} < 30$ mm	1800 lb/ 8.0 kN	1010 lb/ 4.5 kN	14.7 lb-ft/ 20 Nm

**Table 6.3-2: Recommended tension load, shear load and bending moment based on working load concept**

### Group fastenings

Group behavior is affected by stud ductility and actual clearance. In order to cover unfavorable position of studs in rows or rectangular plates, the following rule applies:

	<p>Studs in rows:</p> <ul style="list-style-type: none"> <li>One stud of a row of n (here: n = 4) studs is considered for the total shear load of the row.</li> </ul>
	<p>Studs in rectangular plates:</p> <ul style="list-style-type: none"> <li>Rectangular plate with 4 studs in the corner and shear load introduction in center of plate.</li> <li>Two studs of a group of four studs are considered for the total shear load of the group.</li> </ul>

**i** Remark on design and recommended shear values:  
group behaviour is affected by stud ductility as well as actual clearances.

Figure 6.3-3: Group fastenings

### Load reduction factor for thin parent material

Designation	Thin parent material thickness $t_{II}$	Load reduction factor for		
		Tension load	Shear load	Bending
Metric size				
F-BT-MR M6xL (6)	$2 \leq t_{II} < 4$ mm	$\alpha = (t_{II} + 4)/8$		n. a.
F-BT-MR M8xL (8)	$2 \leq t_{II} < 4$ mm	$\alpha = (t_{II} + 1)/5$		
F-BT-MR M10xL (10)	$2 \leq t_{II} < 6$ mm	$\alpha = (t_{II} + 1.5)/7.5$		
F-BT-MR M12xL (10)	$2 \leq t_{II} < 6$ mm			
Imperial size				
F-BT-MR 3/8xL (3/8)	$0.0787" \leq t_{II} < 0.236"$	$\alpha = (t_{II} + 0.059)/0.295$		

**i** For metric sizes  $t_{II}$  in mm and for imperial sizes in inches.  
When welding onto the minimum defined thicknesses of parent material, the stud's neck is the weakest point, and thus dictates the failure load.  
However, when welding on thinner parent material, the parent material rather than the neck is the weakest point. Therefore, the load values are reduced.  
Consequently, when welding onto thin parent material, a load reduction factor must be considered when calculating design or recommended load values.

Example:

- $N_{rec, red}$  = Reduced recommended load
- $\alpha$  = Load reduction factor
- $N_{rec}$  = Recommended load (on defined parent material thickness)

From test data made as discrete parent material thicknesses,  $\alpha$  load reduction factor formula has been derived for each of the stud types.

Figure 6.3-4: Load reduction factor for thin parent material

## 6.4 Installation recommendations

### 6.4.1 Stud installation

The following guidelines provide the specifications for CSF stud installation. Typically installation will be performed in accordance with a welding code/standard such as EN ISO 14555 or AWS D1.6, which have additional requirements in regards to installation. Please see section 8 for more information regarding processes in keeping with EN ISO 14555.

### 6.4.2 Installation torque

Installation torque with flange lock nut			
Designation	Torque moment $T_{inst}$	Recommended nut type	Tightening tool
Metric size			
F-BT-MR M6xL (6)	8 Nm	Flange lock nut according to EN 1663	Tightening tools with torque control function
F-BT-MR M8xL (8)	20 Nm		
F-BT-MR M10xL (10)	30 Nm		
F-BT-MR M12xL (10)	30 Nm		
Imperial size			
F-BT-MR 3/8xL (3/8)	22 lb-ft/30 Nm	Flange lock nut with locking teeth according to ASME B 18.16.4	Tightening tools with torque control function
F-BT-MR 1/2xL (3/8)	22 lb-ft/30 Nm		

- For more details, please refer to the instructions for use (IFU).
- A powered tightening tool shall not be used.

**Table 6.4.2-1: Installation torque with flange lock nut**

Installation torque with Hot Dip Galvanized (HDG) nut			
Designation	Torque moment $T_{inst}$	Possible nut type	Tightening tool
Metric size			
F-BT-MR M6xL (6)	8 Nm	HDG nut	Tightening tools with torque control function
F-BT-MR M8xL (8)	20 Nm		
F-BT-MR M10xL (10)	27 Nm		
F-BT-MR M12xL (10)	27 Nm		
Imperial size			
F-BT-MR 3/8xL (3/8)	20 lbft/ 27 Nm	HDG nut	Tightening tools with torque control function
F-BT-MR 1/2xL (3/8)	20 lbft/ 27 Nm		

- For more details, please refer to the instructions for use (IFU).
- A powered tightening tool shall not be used.

**Table 6.4.2-2: Installation torque with Hot Dip Galvanized (HDG) nut**

## 7 DESIGN CONCEPT

### 7.1 Partial factor method

EN 1993-1-1: specifies the use of the partial safety factors to be used in for design. The partial safety factor method is a design method by which safety factors are applied to load and material resistances.

Load type: Quasistatic loading

$$S_d \leq R_d$$

$$S_d = \gamma_F \cdot S_k \leq R_d = R_k / \gamma_{M, F-BT}$$

with:

- $S_d$  = Design loads acting on the stud ( $N_{Sd}$ ,  $V_{Sd}$  or  $M_{Sd}$ )
- $S_k$  = Characteristic loads acting on the stud ( $N_{Sk}$ ,  $V_{Sk}$  or  $M_{Sk}$ )
- $\gamma_F$  = Partial safety factor for actions
- $R_d$  = Design resistance of the stud ( $N_{Rd}$ ,  $V_{Rd}$  or  $M_{Rd}$ )
- $R_k$  = Characteristic resistance of the stud ( $N_{Rk}$ ,  $V_{Rk}$  or  $M_{Rk}$ )
- $\gamma_{M, F-BT}$  = Partial safety factor of resistance

$$\gamma_F = 1.40$$

$$\gamma_{M, F-BT} = 2.00$$

### 7.2 Working load concept

The working load concept is a design method by which the actual load is used. The safety in the design can be described with a global safety factor for the load and the material.

Load type: Quasistatic loading

$$S_k \leq R_{rec}$$

$$R_{rec} = R_k / \gamma_{tot} = R_k / (\gamma_{M, F-BT} \cdot \gamma_F) = R_k / (2.0 \cdot 1.4) = R_k / 2.8$$

with:

- $S_k$  = Characteristic loads acting on the stud ( $N_{Sk}$ ,  $V_{Sk}$  or  $M_{Sk}$ )
- $\gamma_{tot}$  = total (global) safety factor
- $R_{rec}$  = Recommended loads ( $N_{rec}$ ,  $V_{rec}$  or  $M_{rec}$ )
- $R_k$  = Characteristic resistance ( $N_{Rk}$ ,  $V_{Rk}$  or  $M_{Rk}$ )
- $\gamma_{M, F-BT}$  = Partial safety factor of resistance

$$\gamma_F = 1.40$$

$$\gamma_{M, F-BT} = 2.00$$



### 7.3 Load interaction

Table 7.3-1 and 7.3-2 provide interaction equations where studs are loaded with tension, shear, and/or moments simultaneously.

Load combination	Load interaction
Shear - Tension	$\frac{V_{Sd}}{V_{Rd}} + \frac{N_{Sd}}{N_{Rd}} \leq 1.2$ with $\frac{V_{Sd}}{V_{Rd}} \leq 1.0$ and $\frac{N_{Sd}}{N_{Rd}} \leq 1.0$
Shear - Bending moment	$\frac{V_{Sd}}{V_{Rd}} + \frac{M_{Sd}}{M_{Rd}} \leq 1.0$
Tension - Bending moment	$\frac{N_{Sd}}{N_{Rd}} + \frac{M_{Sd}}{M_{Rd}} \leq 1.0$
Shear - Tension - Bending moment	$\frac{V_{Sd}}{V_{Rd}} + \frac{N_{Sd}}{N_{Rd}} + \frac{M_{Sd}}{M_{Rd}} \leq 1.0$

**Table 7.3-1: Load interaction for design loads**

Load combination	Load interaction
Shear - Tension	$\frac{V_{Sk}}{V_{rec}} + \frac{N_{Sk}}{N_{rec}} \leq 1.2$ with $\frac{V_{Sk}}{V_{rec}} \leq 1.0$ and $\frac{N_{Sk}}{N_{rec}} \leq 1.0$
Shear - Bending moment	$\frac{V_{Sk}}{V_{rec}} + \frac{M_{Sk}}{M_{rec}} \leq 1.0$
Tension - Bending moment	$\frac{N_{Sk}}{N_{rec}} + \frac{M_{Sk}}{M_{rec}} \leq 1.0$
Shear - Tension - Bending moment	$\frac{V_{Sk}}{V_{rec}} + \frac{N_{Sk}}{N_{rec}} + \frac{M_{Sk}}{M_{rec}} \leq 1.0$

**Table 7.3-2: Load interaction for recommended loads**

## 8 CORDLESS STUD FUSION (CSF) IN KEEPING WITH EN ISO 14555

The purpose of this section is to assist the manufacturer on the Welding Procedure Qualification (WPQ) and the Welding Procedure Specification (WPS) as well as the process control within the Factory Production Control (FPC) according EN ISO 14555 [5].

### Admissible application area

- CSF can be used in all fields of metal-working industry
- Structures subjected to specified static loading
- Standard quality requirements in accordance with ISO 3834-3
- Application temperature in service:  $-40\text{ °C} \leq T \leq 60\text{ °C}$

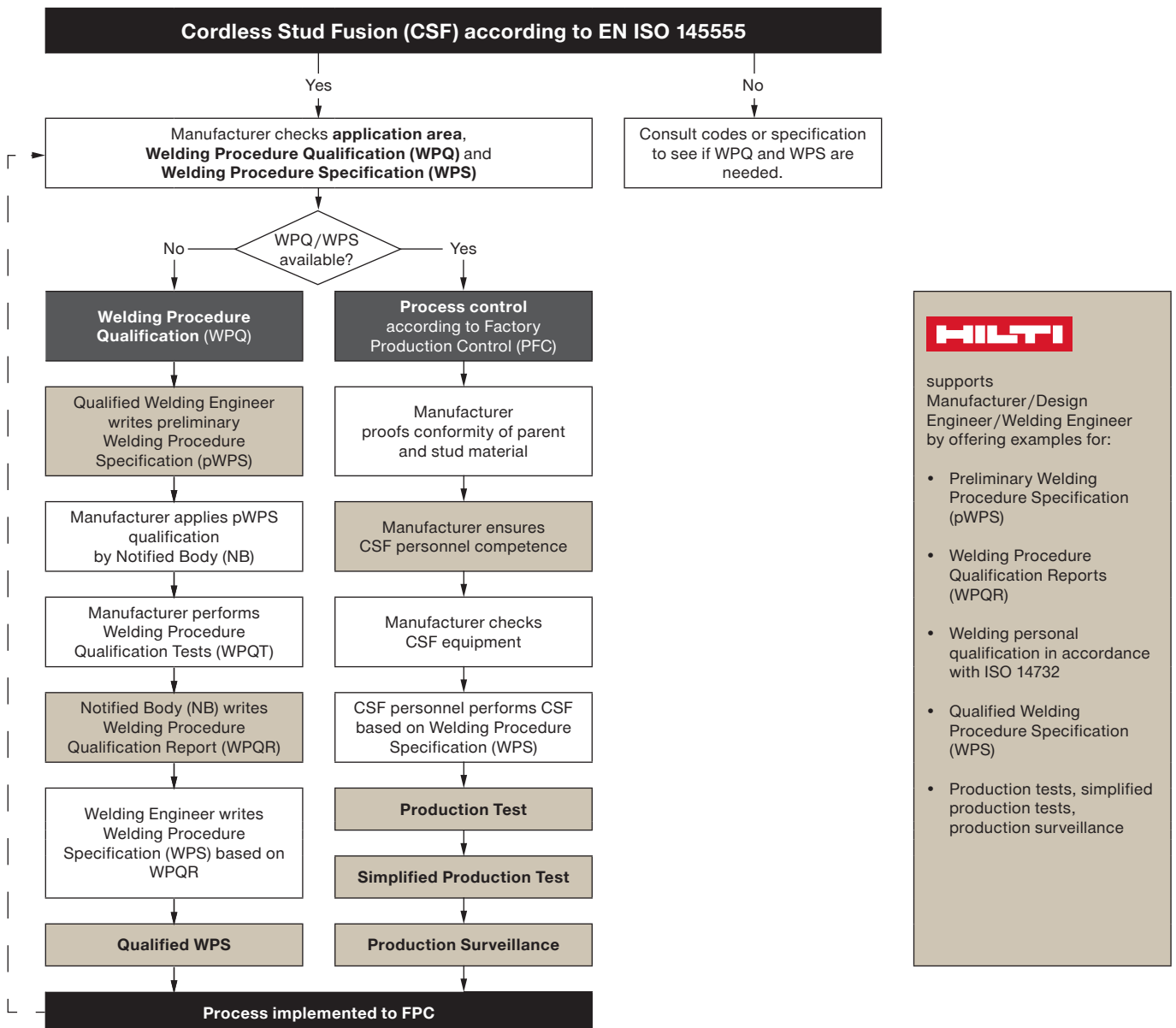

**i** WPQ and process control have to be approved by Notified Body (NB).

**Figure 8-1: Cordless Stud Fusion (CSF) process implementation to FPC**

## 8.1 Welding Procedure Qualification (WPQ)

Typically, Welding Procedure Qualification results in qualified Welding Procedure Specifications (WPS). WPQ is needed when code or specification requires it. The method should be agreed between the contracting parties. Following methods of qualification are permitted, but specification or application code requirements may restrict the choice of method:

- Qualification by welding procedure test
- Qualification by pre-production tests

### 8.1.1 pre-liminary Welding Procedure Specification (pWPS)

Pre-liminary Welding Procedure Specification contains the required variables of the welding procedure to be qualified, including the following information:

- Identification of the manufacturer
- Identification of pWPS
- Welding process
- Environmental conditions
- Surface preparation
- Conditions related to parent material
- Conditions related to stud material
- Conditions related to welding positions

For some applications, it may be necessary to supplement or reduce the list.

**Preliminary Welding Procedure Specification (pWPS)**  
No. pWPS\_F-BT-MR SN (EU)      Version: 03/2022-11-04

Stud welding fastener type designation	<b>F-BT-MR SN</b>	
Studs	F-BT-MR M6x25 SN (8), F-BT-MR M6x25 SN (4) F-BT-MR M8x25 SN (8), F-BT-MR M8x25 SN (4) F-BT-MR M10x25 SN (10), F-BT-MR M10x50 SN (10) F-BT-MR M12x25 SN (10), F-BT-MR M12x50 SN (10) F-BT-MR 3/8x1 SN (3/8), F-BT-MR 3/8x1 1/2 SN (3/8), F-BT-MR 3/8x2 SN (3/8), F-BT-MR 3/8x4 SN (3/8), F-BT-MR 3/8x1 SN (5/32)	
Base material	Subgroups 1.1 and 1.2 according to CEN ISO/TR 15608, CEV ≤ 0.45 %	
Base material shape	Flat steel	
Base material coating	Non-weldable primer HDG coating Duplex coating Multi-layer coating	
Visualization		
Maximum coating thickness	1000 µm	
Surface tool	FX 3-ST d20	
Surface preparation method	Surface preparation with appropriate tool. Prepared surface shall be free of any visible dirt, rust and coating. Surface to be welded shall be maintained dry and free from condensation. Maximum time permitted between surface preparation and welding: 2 hours Consideration of: <b>F-BT Visual Examination Catalogue, 2022-10-28, OTR/5724148/01</b>	
Magnetic clamp and base clamp positioning	PA, PE, PC: Minimum distance to stud welding position $s_{min}$ = 100 mm PC: Clamp positioning below stud welding position	
Positioning in base material	Edge distance $c_{min}$ = 40 mm Spacing between studs $s_{min}$ = 35 mm	
Stud material	Material number 1.4571 EN material designation X6CrNiMoTi17-12-2 AISI/ SAE 316Ti UNS S 31635	

**Preliminary Welding Procedure Specification (pWPS)**  
No. pWPS\_F-BT-MR SN (EU)      Version: 03/2022-11-04

Stud welding equipment																																																																													
Cordless stud fusion unit	FX 3-A																																																																												
Cordless stud fusion hand tool	FX 3-HT																																																																												
Stud holder	X-SH F3 M6-1/4", X-SH F3 M8-5/16", X-SH F3 M10-3/8", X-SH F3 M12-1/2"																																																																												
Stud welding technology	<p>Drawn-arc welding with shielding gas (783) Welding current, welding time, lift and protrusion are automatically adjusted. Gas can FX 3-CC. Shielding gas (SG) according to ISO 14175: M21-Arc-18 Gas flow rate: 3 l/min Preheat base material: 0°C</p>																																																																												
Stud designation	Stud holder	Weld Code	Welding position ISO 8947	Base material Thickness $t_{min}$ / $t_{max}$	Recommended surface tool for base material coating																																																																								
<table border="1"> <thead> <tr> <th>Material and Imperial sizes</th> <th>Stud holder</th> <th>Weld Code</th> <th>Welding position ISO 8947</th> <th>Base material Thickness <math>t_{min}</math> / <math>t_{max}</math></th> <th>Recommended surface tool for base material coating</th> </tr> </thead> <tbody> <tr> <td>F-BT-MR M6x25 SN (8)</td> <td>X-SH F3 M6-1/4"</td> <td>H1</td> <td></td> <td>4 mm / 30 mm</td> <td rowspan="16">FX 3-ST d20</td> </tr> <tr> <td>F-BT-MR M6x25 SN (4)</td> <td>X-SH F3 M8-5/16"</td> <td>H1</td> <td></td> <td>4 mm / 30 mm</td> </tr> <tr> <td>F-BT-MR M8x25 SN (8)</td> <td>X-SH F3 M6-1/4"</td> <td>H2</td> <td></td> <td>6 mm / 30 mm</td> </tr> <tr> <td>F-BT-MR M8x25 SN (4)</td> <td>X-SH F3 M8-5/16"</td> <td>H2</td> <td></td> <td>8 mm / 30 mm</td> </tr> <tr> <td>F-BT-MR M10x25 SN (10)</td> <td>X-SH F3 M10-3/8"</td> <td>H10</td> <td></td> <td>10 mm / 30 mm</td> </tr> <tr> <td>F-BT-MR M10x50 SN (10)</td> <td>X-SH F3 M10-3/8"</td> <td>H10</td> <td></td> <td>10 mm / 30 mm</td> </tr> <tr> <td>F-BT-MR M12x25 SN (10)</td> <td>X-SH F3 M12-1/2"</td> <td>H10</td> <td>PA, PE, PC</td> <td>10 mm / 30 mm</td> </tr> <tr> <td>F-BT-MR M12x50 SN (10)</td> <td>X-SH F3 M12-1/2"</td> <td>H10</td> <td></td> <td>10 mm / 30 mm</td> </tr> <tr> <td>F-BT-MR 3/8x1 SN (5/32)</td> <td>X-SH F3 M10-3/8"</td> <td>H1</td> <td></td> <td>4 mm / 30 mm</td> </tr> <tr> <td>F-BT-MR 3/8x1 1/2 SN (3/8)</td> <td>X-SH F3 M10-3/8"</td> <td>H10</td> <td></td> <td>10 mm / 30 mm</td> </tr> <tr> <td>F-BT-MR 3/8x1 SN (3/8)</td> <td>X-SH F3 M10-3/8"</td> <td>H10</td> <td></td> <td>10 mm / 30 mm</td> </tr> <tr> <td>F-BT-MR 3/8x2 SN (3/8)</td> <td>X-SH F3 M10-3/8"</td> <td>H10</td> <td></td> <td>10 mm / 30 mm</td> </tr> <tr> <td>F-BT-MR 3/8x4 SN (3/8)</td> <td>X-SH F3 M10-3/8"</td> <td>H10</td> <td></td> <td>10 mm / 30 mm</td> </tr> </tbody> </table>						Material and Imperial sizes	Stud holder	Weld Code	Welding position ISO 8947	Base material Thickness $t_{min}$ / $t_{max}$	Recommended surface tool for base material coating	F-BT-MR M6x25 SN (8)	X-SH F3 M6-1/4"	H1		4 mm / 30 mm	FX 3-ST d20	F-BT-MR M6x25 SN (4)	X-SH F3 M8-5/16"	H1		4 mm / 30 mm	F-BT-MR M8x25 SN (8)	X-SH F3 M6-1/4"	H2		6 mm / 30 mm	F-BT-MR M8x25 SN (4)	X-SH F3 M8-5/16"	H2		8 mm / 30 mm	F-BT-MR M10x25 SN (10)	X-SH F3 M10-3/8"	H10		10 mm / 30 mm	F-BT-MR M10x50 SN (10)	X-SH F3 M10-3/8"	H10		10 mm / 30 mm	F-BT-MR M12x25 SN (10)	X-SH F3 M12-1/2"	H10	PA, PE, PC	10 mm / 30 mm	F-BT-MR M12x50 SN (10)	X-SH F3 M12-1/2"	H10		10 mm / 30 mm	F-BT-MR 3/8x1 SN (5/32)	X-SH F3 M10-3/8"	H1		4 mm / 30 mm	F-BT-MR 3/8x1 1/2 SN (3/8)	X-SH F3 M10-3/8"	H10		10 mm / 30 mm	F-BT-MR 3/8x1 SN (3/8)	X-SH F3 M10-3/8"	H10		10 mm / 30 mm	F-BT-MR 3/8x2 SN (3/8)	X-SH F3 M10-3/8"	H10		10 mm / 30 mm	F-BT-MR 3/8x4 SN (3/8)	X-SH F3 M10-3/8"	H10		10 mm / 30 mm
Material and Imperial sizes	Stud holder	Weld Code	Welding position ISO 8947	Base material Thickness $t_{min}$ / $t_{max}$	Recommended surface tool for base material coating																																																																								
F-BT-MR M6x25 SN (8)	X-SH F3 M6-1/4"	H1		4 mm / 30 mm	FX 3-ST d20																																																																								
F-BT-MR M6x25 SN (4)	X-SH F3 M8-5/16"	H1		4 mm / 30 mm																																																																									
F-BT-MR M8x25 SN (8)	X-SH F3 M6-1/4"	H2		6 mm / 30 mm																																																																									
F-BT-MR M8x25 SN (4)	X-SH F3 M8-5/16"	H2		8 mm / 30 mm																																																																									
F-BT-MR M10x25 SN (10)	X-SH F3 M10-3/8"	H10		10 mm / 30 mm																																																																									
F-BT-MR M10x50 SN (10)	X-SH F3 M10-3/8"	H10		10 mm / 30 mm																																																																									
F-BT-MR M12x25 SN (10)	X-SH F3 M12-1/2"	H10	PA, PE, PC	10 mm / 30 mm																																																																									
F-BT-MR M12x50 SN (10)	X-SH F3 M12-1/2"	H10		10 mm / 30 mm																																																																									
F-BT-MR 3/8x1 SN (5/32)	X-SH F3 M10-3/8"	H1		4 mm / 30 mm																																																																									
F-BT-MR 3/8x1 1/2 SN (3/8)	X-SH F3 M10-3/8"	H10		10 mm / 30 mm																																																																									
F-BT-MR 3/8x1 SN (3/8)	X-SH F3 M10-3/8"	H10		10 mm / 30 mm																																																																									
F-BT-MR 3/8x2 SN (3/8)	X-SH F3 M10-3/8"	H10		10 mm / 30 mm																																																																									
F-BT-MR 3/8x4 SN (3/8)	X-SH F3 M10-3/8"	H10		10 mm / 30 mm																																																																									
Stud welding examination																																																																													
Observation of <b>HILTI F-BT Visual Examination Catalogue, 2022-10-28, OTR/5724148/01</b>																																																																													
Stud welding parameters																																																																													
Weld Code	Welding current [A]	Welding time [ms]	Protrusion [mm]	Lift [mm]	Remarks																																																																								
H10	250 - 280	390 - 440	4.40 - 4.80	2.30 - 2.80	with magnet field																																																																								
H3	250 - 280	245 - 285	4.40 - 4.80	2.30 - 2.80	with magnet field																																																																								
H2	250 - 280	150 - 190	4.20 - 4.60	2.30 - 2.80	with magnet field																																																																								
H1	250 - 280	80 - 110	4.20 - 4.60	2.30 - 2.80	with magnet field																																																																								

Figure 8.1.1-1: pre-liminary Welding Procedure Specification (pWPS) example

Hilti provide a complete set of pWPS examples which can function as basis for the Welding Engineer to write a pWPS.

## 8.1.2 Welding procedure qualification test (WPQT)

When welding procedure qualification is required, tests shall be carried out. Tests should be agreed between the contracting parties.

**Welding procedure qualification tests in keeping with EN ISO 14555**

Test type	Test category	Test specimen	Test acceptance criteria
Visual examination	Non-destructive testing (NDT) – surface examination	10 studs	Hilti F-BT visual examination catalogue [10]
	Non-destructive testing (NDT) – stud examination		
	Active Fusion Indicator (AFI) – stud examination		
Physical examination	Destructive testing (DT) – bend testing	10 studs	according to section 8.4.1
	or		
	Destructive testing (DT) – tension testing	5 studs	according to section 8.4.2
Re-testing	If one test fails to meet the requirements, two similar tests can be carried out. If more than one test, or one of the two replacement tests, does not fulfill the acceptance criteria, the test has failed.		

**Table 8.1.2-1: Welding procedure qualification tests**

-  • WPQTs shall be performed on coated material if coated material is the use case.
- Tension testing is recommended as physical examination for F-BT-MR M12 and F-BT-MR M12 SN due to the stud geometry.

## 8.1.3 Welding Procedure Qualification Record (WPQR)

The WPQR is a formally issued document, containing welding procedure details and test results which is written and signed by a Notified Body (NB). The report is required to change a pWPS to a WPS. Hilti support the manufacturer by providing a complete set of WPQR examples (see section 8.5).

## 8.1.4 Qualified Welding Procedure Specification (WPS)

The Welding Procedure Specification (WPS) is a qualified pWPS which specifies the range for all relevant parameters and meets the qualification requirements based on welding qualification tests.

Hilti provides examples of qualified WPS according to EN ISO 14555: CSF-WPS F-BT-MR (EU), Version: 01/2022-11-02 [11].

### 8.1.5 Conditions related to parent material

For the parent material to be used, proof of conformity shall be available. In the absence of the conformity proof, the parent material shall be subjected to additional material tests before welding. For this purpose, the availability of sufficient parent material from the same melt as being used in the testing shall be guaranteed.

Cordless Stud Fusion (CSF) covers the material groups 1.1 or 1.2 in accordance with ISO/TR 15608 [8]. For more details, see Table 8.1.5-1.

**Parent material conditions**

Material groups according to	Welding procedure qualification test performed with	Welding procedure qualification test covers
ISO/TR 15608 [8]	1.1	1.1
	1.2	1.1 and 1.2

**Table 8.1.5-1: Parent material conditions**

Table 9.1.5-2 shows the recommended minimum parent material thicknesses which have been investigated within welding procedure tests by Hilti.

**Recommended minimum parent material thickness**

Welding process	Designation	Designation parent material thickness without backside coating damage
Drawn-arc stud welding with shielding gas (783)	F-BT-MR M6x25 SN (4)	4 mm
	F-BT-MR M8x25 SN (4)	4 mm
	F-BT-MR M6x25 SN (6) F-BT-MR M6x25 (6)	6 mm
	F-BT-MR M8x25 SN (8) F-BT-MR M8x25 (8)	8 mm
	F-BT-MR M10x25 SN (10) F-BT-MR M10x50 SN (10) F-BT-MR M10x25 (10) F-BT-MR M10x50 (10) F-BT-MR M12x25 SN (10) F-BT-MR M12x50 SN (10) F-BT-MR M12x25 (10) F-BT-MR M12x50 (10)	10 mm
	F-BT-MR 3/8x1 SN (5/32)	5/32" / 4mm
	F-BT-MR 3/8x1 SN (3/8) F-BT-MR 3/8x1 1/2 SN (3/8) F-BT-MR 3/8x2 SN (3/8) F-BT-MR 3/8x4 SN (3/8) F-BT-MR 3/8x1 (3/8) F-BT-MR 3/8x1 1/2 (3/8) F-BT-MR 3/8x2 (3/8) F-BT-MR 3/8x4 (3/8) F-BT-MR 1/2x1 1/2 (3/8) F-BT-MR 1/2x2 (3/8)	3/8" / 10 mm

**Table 8.1.5-2: Recommended minimum parent material thickness**

### 8.1.6 Conditions related to stud material

For the stud material the proof of conformity will be provided by Hilti based on request.

A single welding procedure test may cover many different stud designation, but the welding procedure qualification test must consider those with different welding cross sections. Thus, two welding procedure tests using two stud types with two different welding cross sections will cover all stud designations with a welding cross section within the range of the two stud types tested.

### 8.1.7 Conditions related to welding positions

The Cordless Stud Fusion (CSF) process, including the surface preparation and the Cordless Stud Fusion (CSF) itself, can be executed in the following orientations:

- Flat position
- Horizontal position
- Overhead position

Table 8.1.7-1: gives an overview on welding and testing positions.

Welding positions	Flat position	PA
	Horizontal position	PC
	Overhead position	PE
Testing positions	Conditions	<ul style="list-style-type: none"> <li>• PC covers PE and PA, not vice versa</li> <li>• PE covers PA, but not vice versa</li> </ul>

**Table 8.1.7-1: Welding and testing positions**

Welding positions means the orientation of the welded part and the tool and refers to the actual weld position on jobsite.

Testing position means the welding position that is used for Welding Procedure Qualification and operator qualification.

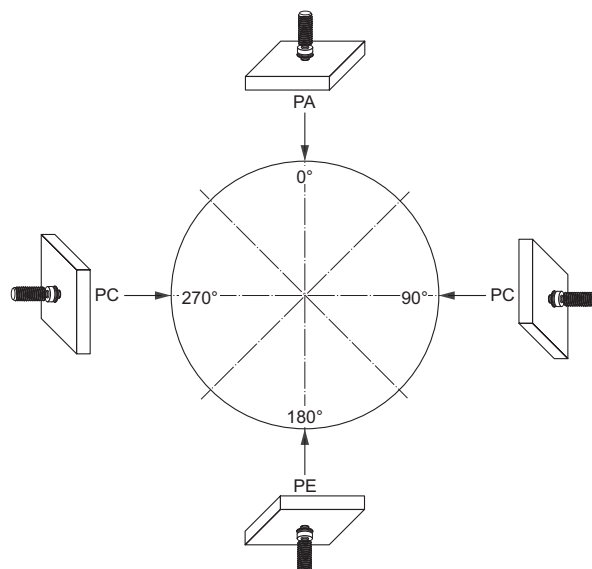

**Figure 8.1.7-1: Welding and testing positions**

## 8.2 Process control

For quality assurance, various quality requirements shall be met, depending on the field of application. Table 8.2-1 gives an overview on process control tests.

Application field	Process control test
Process control in keeping with EN ISO 14555	Production test
	Simplified production test
	Production surveillance

**Table 8.2-1: Process control**

These tests can be carried out by using actual production pieces or by using test specimens. Test specimens shall correspond to production conditions. Repaired studs shall be re-inspected on the same level as originally specified. The visual examination and the physical examination within the process control include non-destructive testing (NDT) and destructive testing (DT). The test category and number of test specimens stated in the following sections shall be used within the process control, unless otherwise specified.

### 8.2.1 Production test

Production test shall be performed on a construction or group of similar constructions by the manufacturer before the welding and/ or after a specified number of welds. This number shall be taken from the relevant application standard or the specification. The production test is limited to the used stud diameter, stud material and parent material. At least 10 studs shall be welded. For re-testing purposes, additional studs should be welded under the same conditions. Table 9.2.1-1 shows examination and testing which shall be performed, unless otherwise specified.

Test type	Test category	Test specimen	Test acceptance criteria
Visual examination	Non-destructive testing (NDT) – surface examination	10 studs	see Hilti F-BT visual examination catalogue [10]
	Non-destructive testing (NDT) – stud examination		
	Active Fusion Indicator (AFI) – stud examination		
Physical examination	Destructive testing (DT) – bend testing	5 studs	according to section 8.4.1
	or Non-destructive testing (NDT) – tension testing with HAT 28-FX	5 studs	according to section 8.4.3
Re-testing	If one test fails to meet the requirements, two similar tests can be carried out. If more than one test, or one of the two replacement tests, does not fulfill the acceptance criteria, the test has failed. Corrective actions shall be taken. Test shall be repeated.		
Recording	The results shall be documented.		

**Table 8.2.1-1: Production test**

## 8.2.2 Simplified production test

Simplified production tests shall be performed by the manufacturer before the start of each shift. Additional tests may be specified.

Test type	Test category	Test specimen	Test acceptance criteria
Visual examination	Non-destructive testing (NDT) – surface examination	3 studs	see Hilti F-BT visual examination catalogue [10]
	Non-destructive testing (NDT) – stud examination		
	Active Fusion Indicator (AFI) – stud examination		
Physical examination	Destructive testing (DT) – bend testing	3 studs	according to section 8.4.1
	or Non-destructive testing (NDT) – tension testing with HAT 28-FX	3 studs	according to section 8.4.3
Re-testing	If one test fails to meet the requirements, two similar tests can be carried out. If more than one test, or one of the two replacement tests, does not fulfill the acceptance criteria, the test has failed. Corrective actions shall be taken. Test shall be repeated.		
Recording	The results shall be documented.		

**Table 8.2.2-1: Simplified production test**

## 8.2.3 Production surveillance

Production surveillance shall be performed by the manufacturer. Generally, visual examination is sufficient for production surveillance. If visual examination fails, physical examination can be carried out in addition.

Test type	Test category	Test specimen	Test acceptance criteria
Visual examination	Non-destructive testing (NDT) – surface examination	all	see Hilti F-BT visual examination catalogue [10]
	Non-destructive testing (NDT) – stud examination		
	Active Fusion Indicator (AFI) – stud examination		
Physical examination	Destructive testing (DT) – bend testing	failed visual examination	according to section 8.4.1
	or Non-destructive testing (NDT) – tension testing with HAT 28-FX	failed visual examination	according to section 8.4.3
Re-testing	If the physical examination does not fulfill the acceptance criteria, the test has failed. Corrective actions shall be taken, see EN ISO 14555 [5], section 14.7.		
Recording	The results shall be documented.		

**Table 8.2.3-1: Production surveillance**



## **8.3 Cordless Stud Fusion (CSF) personnel**

Basic requirements for the manufacturer are to ensure that all the relevant standards and specifications that the Cordless Stud Fusion (CSF) personnel need to meet during the fabrication sequence are in place and in order. Cordless Stud Fusion (CSF) personnel can be subdivided into inspection and operator personnel. The Cordless Stud Fusion (CSF) personnel shall be qualified in accordance with relevant standards (EN ISO 14731 [6], EN ISO 14732 [7]).

### **8.3.1 Inspection personnel**

When inspection is required by an application standard or by specification, the inspection personnel shall check the following aspects: technical review and inspection report. Carrying out technical reports and inspection reports can be done by qualified inspection personnel.

### **8.3.2 Technical review**

The following aspects have typically to be considered before, during, or after the Cordless Stud Fusion (CSF) process:

- Inspect equipment
- Approve parent material specification and parent material properties
- Identify stud location, including accessibility, accessibility for inspection and for non-destructive testing
- Nominate load conditions
- Analyze relevant environmental conditions, e.g. very low ambient temperature conditions
- Provide protection against adverse environmental conditions
- Examine quality requirements and acceptance criteria
- Define approach for the welding procedure qualification, in accordance with Notified Body's (NB) requirements
- Define quality control measures, in accordance with Notified Body's (NB) requirements
- Provide inspection report, if contractually stipulated
- Ensure operator qualification, in accordance with Notified Body's (NB) requirements
- Handle non-conformance(s)
- Define repair work and modification

### **8.3.3 Inspection record**

When an inspection record is contractually stipulated it might be necessary to show that surface preparation and studs have been checked at specified stages and that all acceptance criteria are fulfilled. Form of an inspection record can vary. It is up to the manufacturer to decide.

### 8.3.4 Operator personnel

The Cordless Stud Fusion (CSF) operator qualification can be done within the welding procedure qualification, the process control or as a separate test. Cordless Stud Fusion (CSF) operator personnel need to be able to understand Welding Procedure Specifications (WPSs), shall have appropriate knowledge to operate the equipment, and be able to carry out the welding correctly. The testing shall cover as minimum:

#### Operator personnel qualification test categories

Functional knowledge (normative) according to EN ISO 14732, Annex A	basic knowledge about equipment
	basic assessment of imperfections
	carrying out surface preparation and stud fusion
Welding technology (informative) according to EN ISO 14732, Annex B	

Table 8.3.4-1: Operator personnel qualification test categories

As part of the Cordless Stud Fusion (CSF) operator training, an example of theoretical testing has been given by Hilti which can function as a guideline for the manufacturers within the operator qualification. The testing shall be in accordance with the specified acceptance criteria.

### 8.4 Visual examination and physical examination details

The visual examination is described in the separate document Hilti F-BT visual examination catalogue [10]. The examination catalogue is identified via the Hilti document number OTR 5724148 current Revision 01, issued October 28, 2022.

Physical examination details are given in section 8.4.1 to 8.4.3. Tests shall be selected according to the application. In certain applications, additional tests may be required by applications standards or specifications.

#### 8.4.1 Destructive testing (DT) – bend testing

Stud type: F-BT-MR SN	Stud type: F-BT-MR	Description
		<ul style="list-style-type: none"> <li>Use bend device FX 3-SP S</li> </ul> or <ul style="list-style-type: none"> <li>Position bending device above the neck at the threaded section</li> <li>Bending device shall be positioned to allow rotation of necked section</li> </ul>

Figure 8.4.1-1: Bend device

Test description	Acceptance criteria
 <ul style="list-style-type: none"> <li>Bend stud to an angle <math>\alpha \geq 60^\circ</math> according to EN ISO 14555</li> </ul>	<ul style="list-style-type: none"> <li>Test passes if no cracks are found in the weld after bend</li> </ul>

Figure 8.4.1-2: Bend testing

### 8.4.2 Destructive testing (DT) – tension test

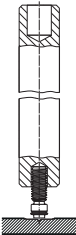
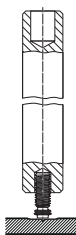
Test description		Acceptance criteria
<p style="text-align: center;">Nut Stud Parent Material</p>	<ul style="list-style-type: none"> <li>Pull welded stud until fracture</li> </ul>	<ul style="list-style-type: none"> <li>Fractures in the weld zone or the neck area are permitted if the nominal stud material tensile strength <math>N_{min}</math> is reached:  M6, M8, 3/8 (H1): <math>N_{min} = 7.5 \text{ kN}</math>  M6 (H2): <math>N_{min} = 9.1 \text{ kN}</math>  M8 (H3): <math>N_{min} = 17.0 \text{ kN}</math>  M10, M12, 3/8, 1/2 (H10): <math>N_{min} = 21.8 \text{ kN}</math> </li> <li>Imperfections in the fracture surface shall be less than 10% of the welded area acc. to EN ISO 14555 [5], 12.1 and 12.4</li> </ul>

Figure 8.4.2-1: Destructive tension test

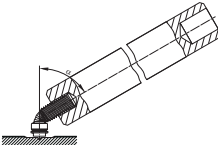
**i**  $N_{min}$  is calculated as the product of the cross sectional neck area of the stud and the minimum specified stud material strength of 600 N/mm<sup>2</sup>.

### 8.4.3 Non-destructive testing (NDT) – tension test (HAT 28-FX)

Test description		Acceptance criteria
	<ul style="list-style-type: none"> <li>Pull welded stud until tensile proof load is reached</li> </ul>	<ul style="list-style-type: none"> <li>No fracture until then the proof load is reached:  M6, M8, 3/8 (H1): 1350 lb/ 6 kN  M6 (H2): 1225 lb/ 9 kN  M8 (H3): 3820 lb/ 17 kN  M10, M12, 3/8, 1/2 (H10): 4950 lb/ 22 kN </li> <li>See Hilti F-BT visual examination catalogue [10], table 6 for more details</li> </ul>

Figure 8.4.3-1: Non-destructive tension test

## 8.5 Technical reports

### 8.5.1 WPQR, macro examinations and hardness measurements

#### Test conditions

- Parent material: S355 per EN 10025-2
- Welding position: Horizontal position (PC)

Designation	H-Code	Welding procedure qualification report (WPQR)	Macro examinations	Hardness measurements	Authority
F-BT-MR M6x25 SN (4) F-BT-MR M8x25 SN (4) F-BT-MR 3/8x1 SN (5/32)	H1	L22/0869_01	L22/0869_02	L22/0869_3	gbd Lab GmbH, Austria
F-BT-MR M6x25 SN (6)	H2	L22/0868_01	L22/0868_02	L22/0868_3	
F-BT-MR M8x25 SN (8)	H3	L22/0867_01	L22/0867_02	L22/0867_3	
F-BT-MR M10xL SN (10) F-BT-MR 3/8xL SN (3/8)	H10	L22/1282_01	L22/1282_02		
F-BT-MR M12xL SN (10)	H10	L22/1281_01	L22/1281_02		
F-BT-MR M6x25 (6)	H2	L22/0873_01			
F-BT-MR M8x25 (8)	H3	L22/0872_01			
F-BT-MR M10xL (10) F-BT-MR 3/8xL (3/8)	H10	L22/1284_01	L22/1284_02		
F-BT-MR M12xL (10) F-BT-MR 1/2xL (3/8)	H10	L22/1283	L22/1282_02		

### 8.5.2 Tension tests

#### Test conditions

- Failure mode (all tests): fracture of the stud neck

Designation	Report no.	Authority
F-BT-MR M6x25 (6) F-BT-MR M8x25 (8) F-BT-MR M10x25 (10) F-BT-MR M12x25 (10) F-BT-MR M6x25 SN (4) F-BT-MR M6x25 SN (8) F-BT-MR M8x25 SN (8) F-BT-MR M12x25 SN (10) F-BT-MR 3/8x1 SN (3/8)	L22/0862_01	gbd Lab GmbH, Austria
F-BT-MR M10x50 SN (10) F-BT-MR M12x50 SN (10) F-BT-MR M10x50 SN (10) F-BT-MR M12x50 SN (10)	L22/0862_02	

### 8.5.3 Shear tests

---

#### Test conditions

---

- Failure mode (all tests): fracture of the weld

Designation	Report no.	Authority
F-BT-MR M6x25 SN (4) F-BT-MR M6x25 SN (6) F-BT-MR M8x25 SN (8) F-BT-MR M10x25 (10) F-BT-MR M10x25 SN (10) F-BT-MR M12x25 SN (10) F-BT-MR M6x25 (6) F-BT-MR M8x25 (8) F-BT-MR M10x25 (10) F-BT-MR M12x25 (10)	L22/0862_03a	gbd Lab GmbH, Austria

## 8.6 Terms and definitions

For the purpose of this document, the following symbols apply.

### Dimensions

$d_1$	nominal diameter, thread diameter
$d_2$	diameter of weld area
$d_{h1}$	diameter of sealing washer interface/diameter of stud area
$d_{h2}$	diameter of stud holder interface
$d_n$	diameter of necking area of stud
L	thread length
$L_1$	nominal stud length

### Spacing and distances

c	edge distance
$c_{min}$	minimum allowable edge distance
s	spacing
$s_{min}$	minimum allowable spacing

### Fastened material and parent material

$d_f$	diameter of clearance hole in the fixture
$t_1$	fastened material thickness
$t_{II}$	parent material thickness
$t_c$	parent material coating thickness

### Forces

F	Force in general
N	Tension force
V	Shear force
M	Moment

T	Torque moment
$T_{inst}$	Installation torque moment

### Basic welding parameters

E	Energy, expressed in Joule (J)
I	Current intensity, expressed in Ampere (A)
U	Charging voltage, expressed in Volt (V)

### Assessment

$\alpha$	Load reduction factor
----------	-----------------------

## 8.7 Abbreviations

CEV	Carbon equivalent value
EN	European de Normalisation
FPC	Factory Production Control
HAZ	Heat Affected Zone
ISO	International Organisation for Standardisation
NB	Notified Body
pWPS	Pre-liminary Welding Procedure Specification
WPQR	Welding Procedure Qualification Record
WPQT	Welding Procedure Qualification Test
WPS	Welding Procedure Specification

## 9 SPECIFIC ASPECTS OF PERFORMANCE

### 9.1 General

The performance of the F-BT studs was determined by means of comprehensive experimental investigations performed throughout the development of the system. These internal tests were complemented by test programs performed by accredited external laboratories. Section 8.5 offers a survey of respective test reports.

In case background information related with the performance of the studs or the application itself is requested or needed for product specification, please inquire at Hilti.

Such information may concern aspects like:

- Robustness of F-BT studs to resist dynamic loading.
- Shear-tension interaction behaviour.
- Durability details.
- Effect of welding direction on performance.
- F-BT weld hardness considerations.

### 9.2 Effect of F-BT studs on fatigue strength of parent material

The effect of welded shear studs on the fatigue strength of the base construction steel is given with Detail Category (DC) 80 according to Eurocode EN 1993-1-9:2005 [15]. Hilti already performed a set of fatigue tests – with flat steel coupons to which F-BT studs were welded – for explicit validation of DC 80 for consideration of the effect of F-BF-studs. The relevant test parameters are summarized in Table 9.2-1.

Name of series	Steel grade	Thickness t [mm]	Stress ratio R [-]	Installation condition	No. of test specimens
355-15-03-w	S355J2+N	15	0.3	Correct weld	10
355-15-05-w			0.5		8
355-15-01-w			0.1		4

**Table 9.2-1: Scope of initial fatigue test program of coupons with F-BT studs**

#### Observations and next steps:

- The F-BT test results clearly exceed the DC 80 ( $m = 3$ ), which confirms that DC 80 given in the Eurocode can be conservatively applied for construction steel with welded F-BT studs.
- The initial data further suggests that a higher category than DC 80 ( $m = 3$ ) may possibly be applied for consideration of the effect of the F-BT studs. This beneficial behaviour is explained with smaller heat affected zones – when applying the CSF weld parameters – in the parent material compared with fully welded headed studs with a typical diameter of 19 or 22 mm.
- The data also shows that the current category DC 100 ( $m = 5$ ) for the X-BT fasteners is met with the F-BT studs. Two runouts were observed at stress ranges of about  $\Delta\sigma = 150\text{--}170\text{ N/mm}^2$ . These runouts indicate enough margin towards the constant amplitude fatigue threshold of  $\Delta\sigma = 83.2\text{ N/mm}^2$  for DC 100 ( $m = 5$ ).
- In order to establish a detail category greater than DC 80 ( $m = 3$ ), additional fatigue tests are necessary to support the existing results. Main parameters of this upcoming test program are variations in steel grade and base material thickness.



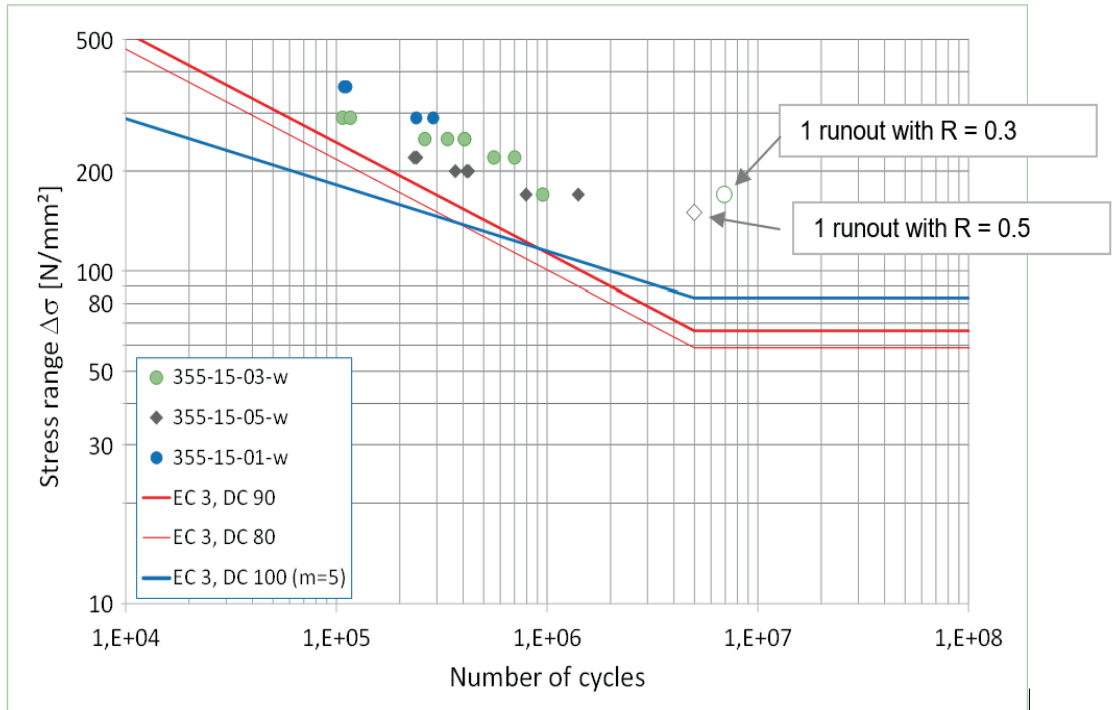

Figure 9.2-1: Initial fatigue tests results of parent steel with F-BT threaded studs

## 10 CORDLESS STUD FUSION (CSF) PROGRAM

### 10.1 Surface preparation equipment

Item no. and description for stud fusion equipment		
Designation	Item no.	Description
SF 8M-A22	Local item: 2061288, 2061305, 2123924	Cordless drill driver
SF 6H-22	2254917	Cordless hammer drill driver
FX 3-ST d14	2270514	Surface tool for uncoated parent material or weldable primer on parent material
FX 3-ST d20	2270512	Surface tool for coated parent material

### 10.2 Stud fusion equipment

Item no. and description for stud fusion equipment		
Designation	Item no.	Description
FX 3-BC	2257272	Base clamp
C 53	Local item: 2270518, 2270519, 2270520, 2270521, 2270522, 2270524, 2270525	CSF Charger
FX 3-HT	Local item: 2280108, 2270527, 2270528, 2270529, 2270526	Cordless stud fusion hand tool
FX 3-A	Local item: 2331460, 2270477, 2270478, 2270479, 2270510, 2270511	Cordless stud fusion unit
FX 3-GC	2241926	Gas can
X-SR F3	2331667	Hand tool shielding ring
X-SL F3	2331668	Hand tool support leg
X-GC F3	2257272	FX ground cable
X-MC F3	2259030	Magnetic ground clamp
X-SH F3 M6 – 1/4"	2257273	Stud holder
X-SH F3 M8 – 5/16"	2257274	
X-SH F3 M10 – 3/8"	2257275	
X-SH F3 M12 – 1/2"	2257271	
X-SH F3-MIX	2294502	Stud holder mix
X-SHT F3	2293828	Stud holder change tool

• Local items: based on market regulation, one unique item out of the list would be available.

### 10.3 Installation equipment

#### Item no. and description for installation equipment

Designation	Item no.	Description
X-WST F3-BT	2278582	SCF washer setting tool and adaptors for metric (M6, M8, M10, M12) and imperial (3/8", 1/2") studs
X-WCG F3-BT	2331669	Washer check gauge

### 10.4 Studs

#### Item no. and description for F-BT-MR studs without sealing washer

Designation	Item no.	Description
Metric sizes		
F-BT-MR M6x25 (6)	2293866	For fastening to standard parent material thickness
F-BT-MR M8x25 (8)	2293867	
F-BT-MR M10x25 (10)	2293868	
F-BT-MR M10x50 (10)	2293869	
F-BT-MR M12x25 (10)	2293870	
F-BT-MR M12x50 (10)	2293871	
Imperial sizes		
F-BT-MR 3/8x1 (3/8)	2293890	For fastening to standard parent material thickness
F-BT-MR 3/8x1 1/2 (3/8)	2293891	
F-BT-MR 3/8x2 (3/8)	2293892	
F-BT-MR 3/8x4 (3/8)	2293893	
F-BT-MR 1/2x1 1/2 (3/8)	2293895	
F-BT-MR 1/2x2 (3/8)	2293896	

---

**Item no. and description for F-BT-MR SN studs with sealing washer**

Designation	Item no.	Description
Metric sizes		
F-BT-MR M6x25 SN (4)	2346394	For fastening to thin parent material
F-BT-MR M8x25 SN (4)	2293865	
F-BT-MR M6x25 SN (6)	2293829	For fastening to standard parent material thickness
F-BT-MR M8x25 SN (8)	2293860	
F-BT-MR M10x25 SN (10)	2293861	
F-BT-MR M10x50 SN (10)	2293862	
F-BT-MR M12x25 SN (10)	2293863	
F-BT-MR M12x50 SN (10)	2293864	
Imperial sizes		
F-BT-MR 3/8x1 SN (5/32)	2293887	For fastening to thin parent material
F-BT-MR 3/8x1 SN (3/8)	2293880	For fastening to standard parent material thickness
F-BT-MR 3/8x1 1/2 SN (3/8)	2293881	
F-BT-MR 3/8x2 SN (3/8)	2293882	
F-BT-MR 3/8x4 SN (3/8)	2293883	

## 10.5 Support plate

---

**Item no. and description for support plate**

Designation	Item no.	Description
FX 3-SP S	2360102	CSF support plate for M6, M8, M10

## 10.6 Test equipment

---

**Item no. and description for test equipment**

Designation	Item no.	Description
X-BB F3	2401712	Bending bar
HAT 28 M kit	355338	Anchor tester

## 11 REFERENCES

- [1] EN ISO 3834-4: Quality requirements for fusion welding of metallic materials – Part 3: standard quality requirements, 2021.
- [2] EN ISO 6947: Welding and allied processes – welding positions, 2011.
- [3] EN ISO 13918/A1: Welding – studs and ceramic ferrules for arc stud welding, CEN/TC 121 – Welding, 2021.
- [4] EN ISO 14175: Welding consumables – Gases and gas mixtures for fusion welding and allied processes, 2018.
- [5] EN ISO 14555: Welding – Arc stud welding of metallic materials, 2007.
- [6] EN ISO 14731: Welding coordination, tasks and responsibilities, 2019.
- [7] EN ISO 14732: Welding personnel – Qualification testing of welding operators and weld setters for mechanized and automatic welding of metallic materials, 2013.
- [8] CEN ISO/TR 15608: Welding – Guidelines for a metallic materials grouping system.
- [9] EN 10204: Metallic – products – Types of inspection documents, 2004.
- [10] Hilti F-BT visual examination catalogue, OTR 5724148/01, October 28, 2022.
- [11] Hilti, Weld Procedure Specification: CSF-WPS F-BT-MR (EU), Version: 01/2022-11-02
- [12] AWS B2.1: Specification for Welding Procedure and performance Qualification, 2005
- [13] AWS D1.1/D1.1M: Structural Welding Code – Steel, 2020.
- [14] AWS D1.6/D1.6M: Structural Welding Code – Stainless steel, 2017.
- [15] EN 1993-1-9: 2005: Eurocode 3: Design of steel structures – Part 1–9: Fatigue, European Standard, May 2005.







Hilti Corporation  
9494 Schaan, Liechtenstein  
P +423-234 2965

[www.facebook.com/hiltigroup](https://www.facebook.com/hiltigroup)  
[www.hilti.group](http://www.hilti.group)