

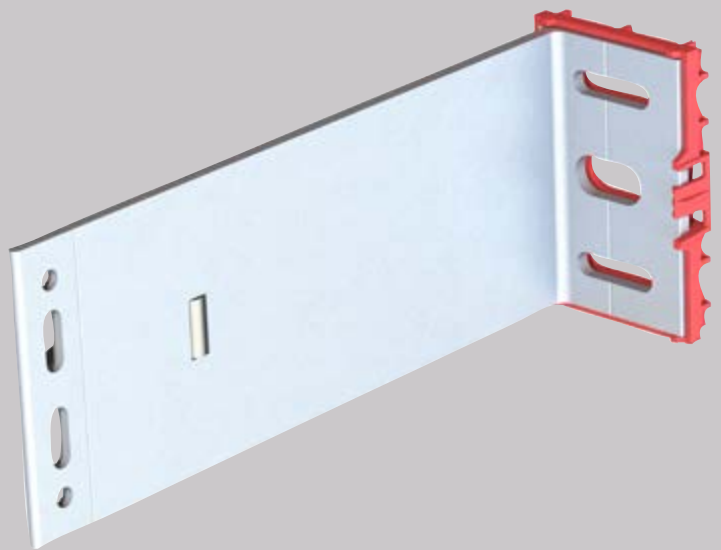

MFT-FOX VI-1L- BOLTS

Hilti facade system



CONTENT AND OVERVIEW

Panels	3
Application and Description	4
System Drawings	5-15
Brackets Range	
MFT-FOX VI Small	16
MFT-FOX VI Medium	17
MFT-FOX VI Large	18
Bracket Profile Adjustment	19
Products Range	20-21

MFT-FOX VI-1L-bolts



Metal



Composite



This is an interactive page! Click on the move-back button to jump back to the CONTENT AND OVERVIEW.



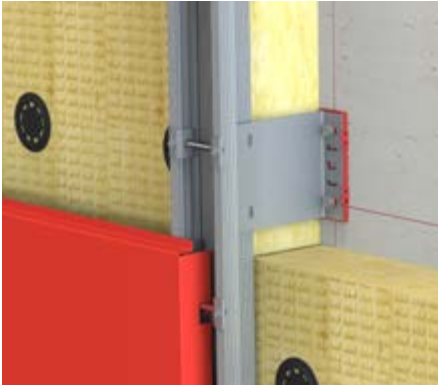

APPLICATION AND DESCRIPTION

MFT-FOX VI-1L-bolts

The system consists of aluminum brackets and profiles, and the system is specifically designed for vertical substructures in ventilated facades by using cassettes as cladding material.

The brackets are supplied with pre-assembled isolators and, according to the method of installation to the base material – anchors, screws or direct fastening – with different hole geometries in the base plate (available hole geometries are shown in the catalogue or on the following pages).

The brackets are designed with both fixed and flexible points to allow for thermal expansion of the profile. The fixed point takes the weight of the panels and substructure and the proportional wind loads, while the flexible point only assumes the proportional wind loads.

The vertical profiles are connected to the brackets with specially designed screws for fixed and flexible points. The fixed points do not allow the profiles vertical movement against the brackets, while the flexible points allow virtually frictionless sliding of the profiles against the brackets. The flexible point makes sure that there are no additional loads on the substructure from the profile's expansion forces.

The adjustment of the profiles against the brackets is facilitated by a 'helping hand'. The helping hand keeps the profile in position whilst the profile is being fixed with screws, allowing a fast connection to the bracket. With this system, wall tolerances of up to 40 mm can be perfectly balanced. The brackets are available in 3 different sizes (large, medium & small) from 40 mm to 300 incl. 6mm isolator in 20 mm increments. The isolator separates the substructure from the base material to reduce thermal bridging.

The vertical profiles are specially designed for cassettes as cladding material. The aluminum bolt supports the cassette and transfers the load into the substructure. The aluminum bolt can be mounted at any time, and it is not necessary to pre-assemble the bolt in the profile. The bolt is fixed with two clamps to the profile. The position of the bolt is adjustable and not fixed by preset grids.

Advantages

- Flexible design using fixed and flexible points
- 3 different sizes of brackets (large, medium & small)
- 40 mm adjustment capability of the profiles in the brackets
- Brackets can be mounted using a range of methods - anchors, screws or direct fastening
- 6 mm isolator separates the substructure from the base material to reduce thermal bridging
- Substructures can be designed with PROFIS Facade to generate technically-sound and economically optimized solutions
- Can be used with all common cassettes

VIEW OF CLADDING

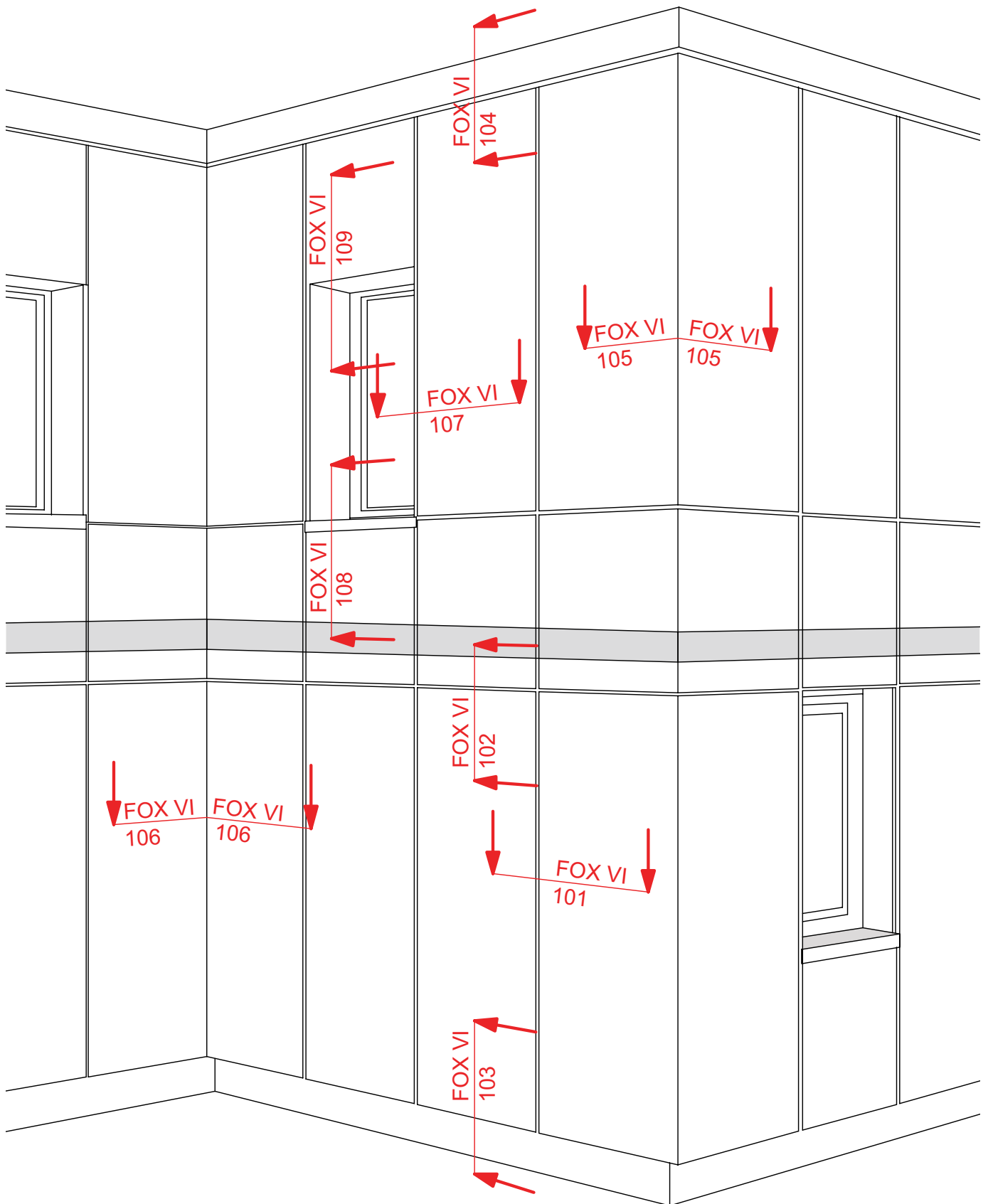

This is an interactive page! By clicking on a system part you get directed to the respective detail page.
Click on the move-back button to jump back to the CONTENT AND OVERVIEW.

MFT-FOX VI 101

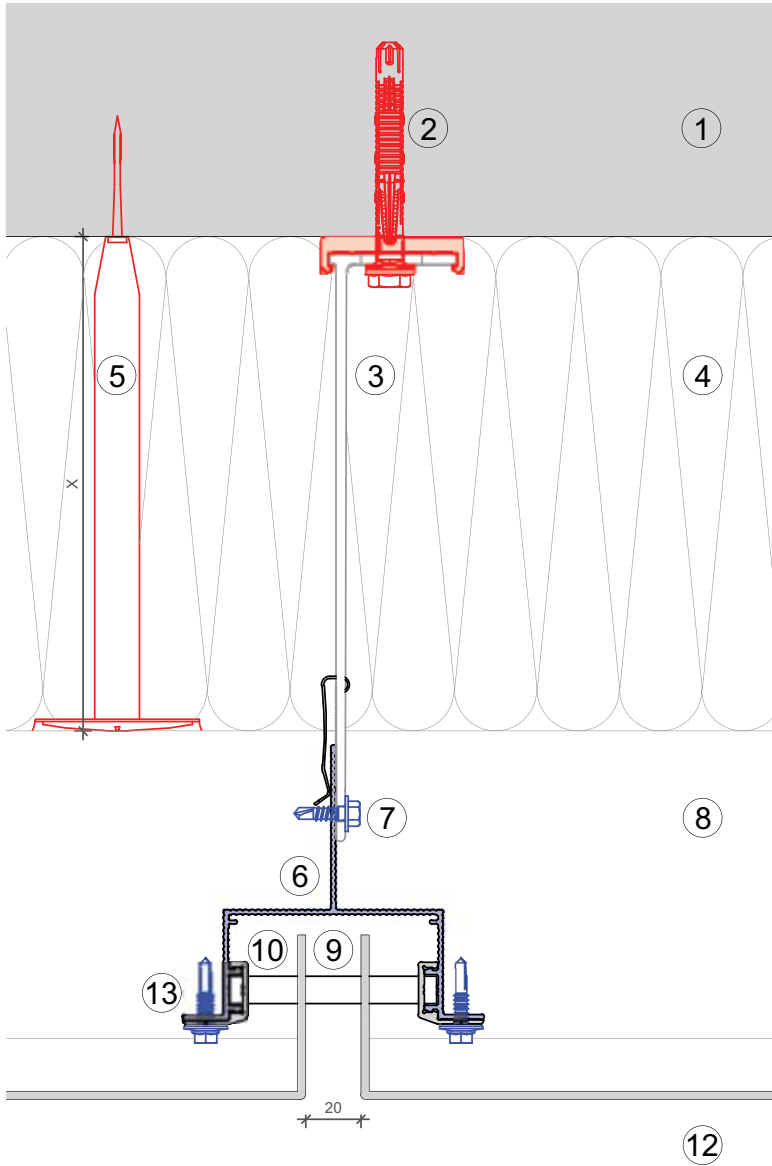

Legend:

- ① Base material
- ② Anchor acc. to static
- ③ Bracket and isolator MFT-FOX VI
- ④ Insulation
- ⑤ Fixing insulation
- ⑥ Profile MFT-CP T
- ⑦ Self drilling screw
- ⑧ Ventilation gap
- ⑨ Aluminum-bolt MFT-C BO
- ⑩ Clip MFT-C
- ⑫ Cladding

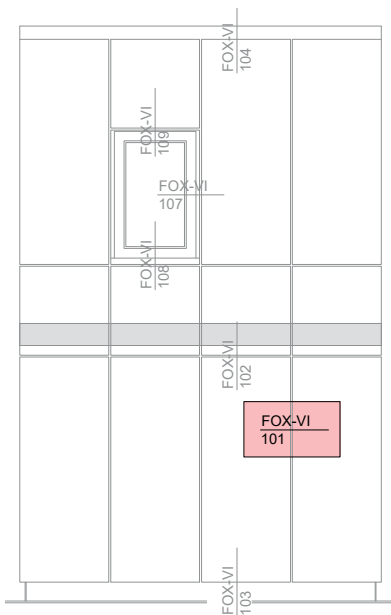

This is an interactive page! Click on the move-back button to jump back to the VIEW OF CLADDING.

MFT-FOX VI 102

Legend:

- ① Base material
- ② Anchor acc. to static
- ③ Bracket and isolator MFT-FOX VI
- ④ Insulation
- ⑤ Fixing insulation
- ⑥ Profile MFT-CP T
- ⑦ Self drilling screw
- ⑧ Ventilation gap
- ⑨ Aluminum-bolt MFT-C BO
- ⑩ Clip MFT-C
- ⑪ Fixing cladding
- ⑫ Cladding

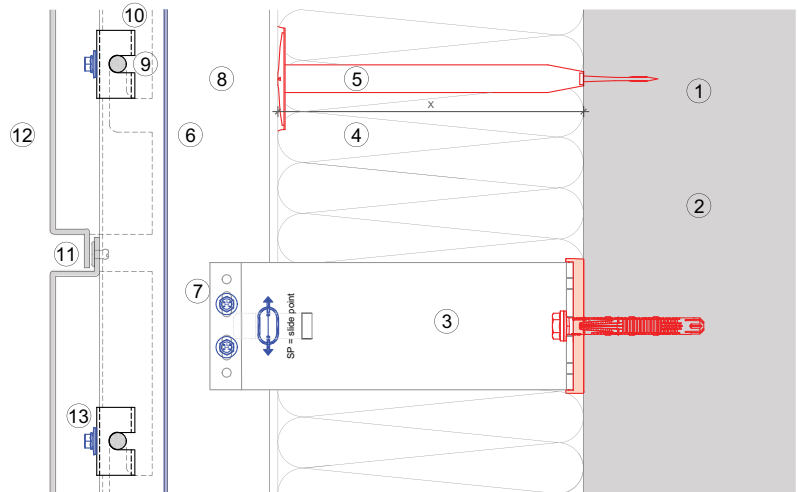

Vertical section-fixed point

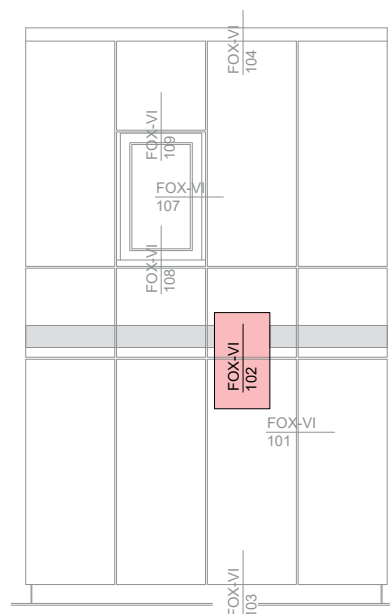
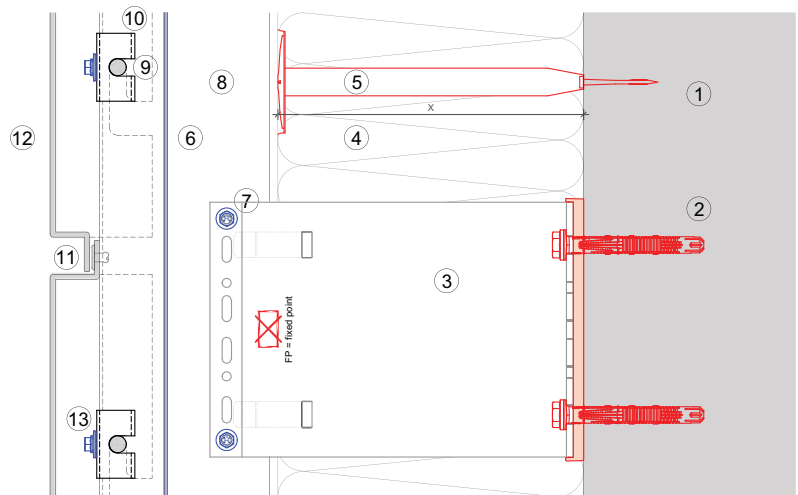

This is an interactive page! Click on the move-back button to jump back to the VIEW OF CLADDING.



MFT-FOX VI 103

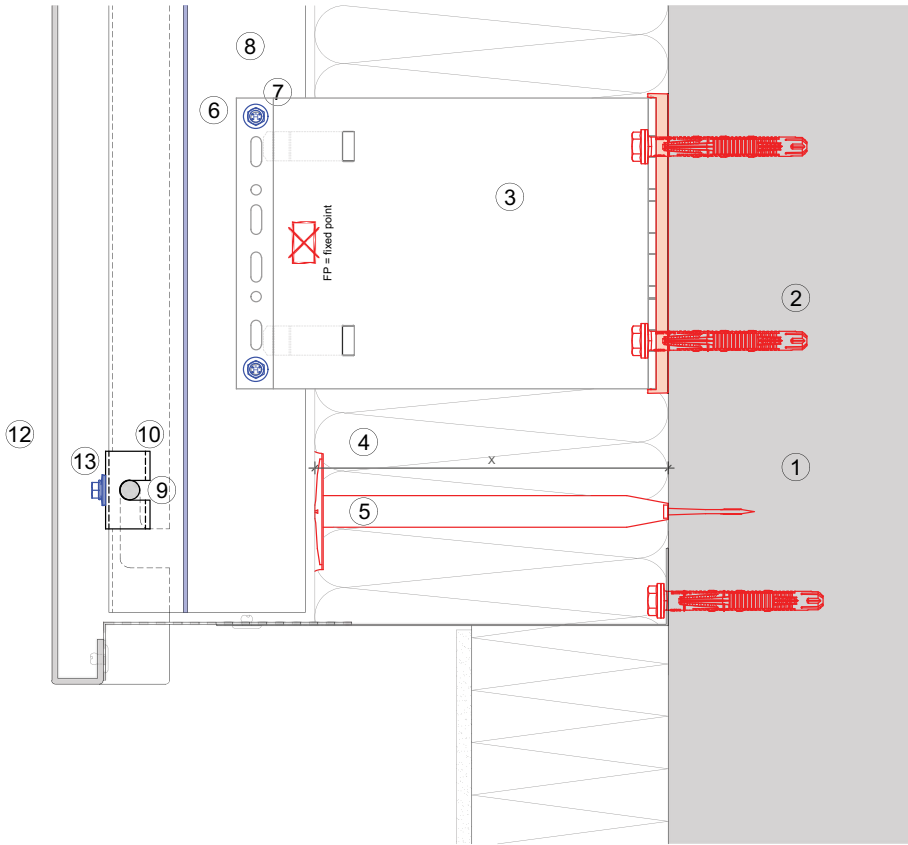

Legend:

- ① Base material
- ② Anchor acc. to static
- ③ Bracket and isolator MFT-FOX VI
- ④ Insulation
- ⑤ Fixing insulation
- ⑥ Profile MFT-CP T
- ⑦ Self drilling screw
- ⑧ Ventilation gap
- ⑨ Aluminum-bolt MFT-C BO
- ⑩ Clip MFT-C
- ⑪ Cladding

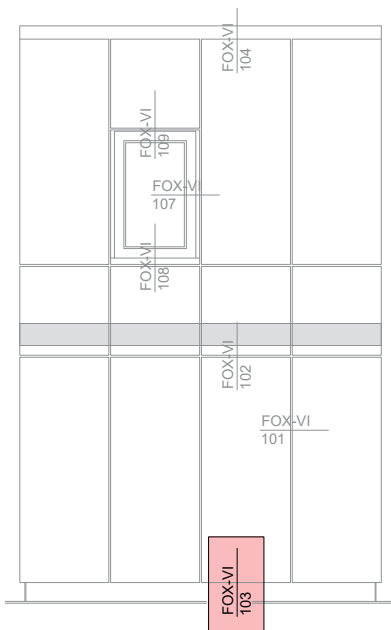

This is an interactive page! Click on the move-back button to jump back to the VIEW OF CLADDING.

MFT-FOX VI 104

Legend:

- ① Base material
- ② Anchor acc. to static
- ③ Bracket and isolator MFT-FOX VI
- ④ Insulation
- ⑤ Fixing insulation
- ⑥ Profile MFT-CP T
- ⑦ Self drilling screw
- ⑧ Ventilation gap
- ⑨ Aluminum-bolt MFT-C BO
- ⑩ Clip MFT-C
- ⑪ Fixing cladding
- ⑫ Cladding

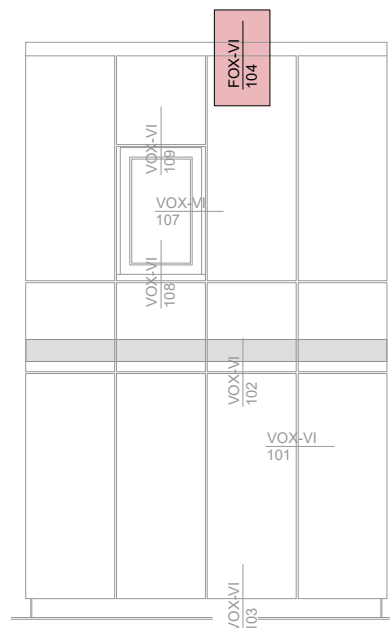
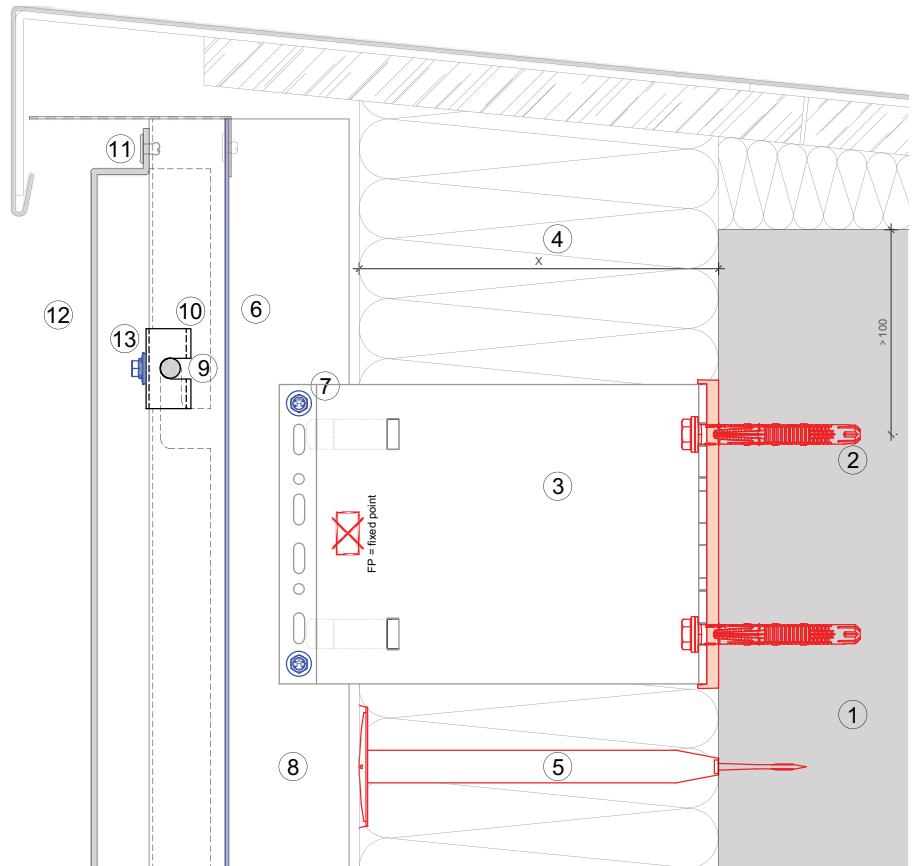

This is an interactive page! Click on the move-back button to jump back to the VIEW OF CLADDING.



MFT-FOX VI 105

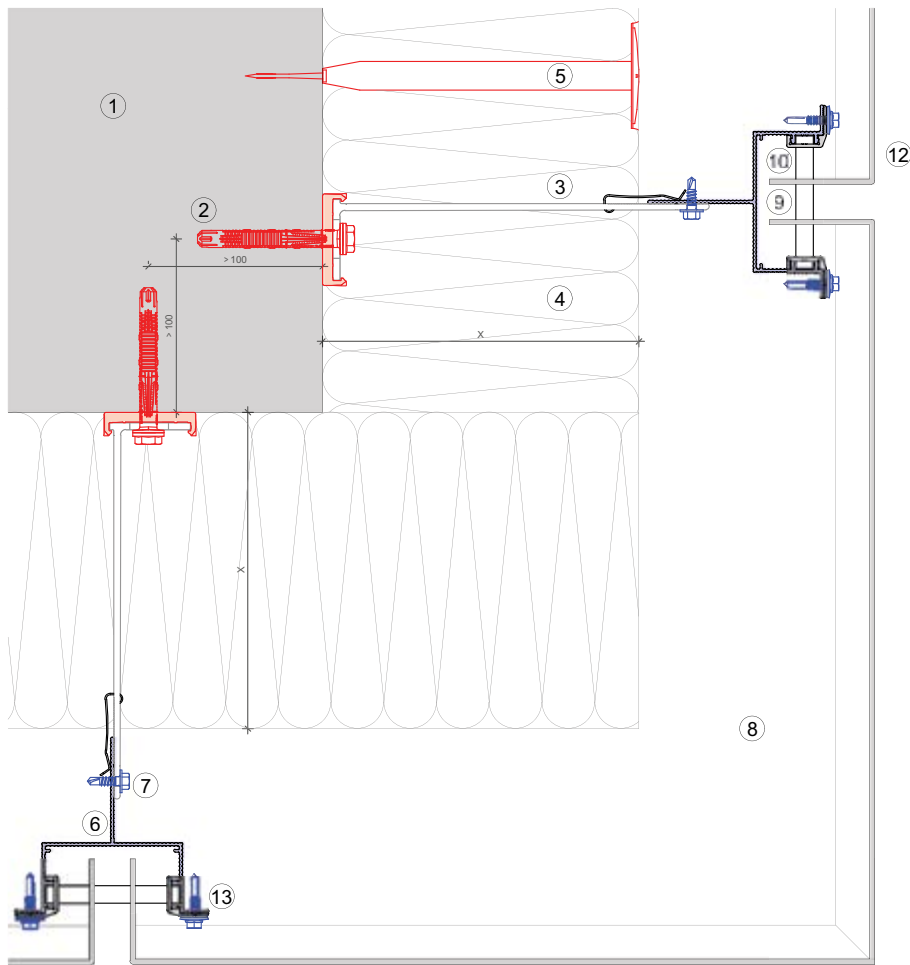

Legend:

- ① Base material
- ② Anchor acc. to static
- ③ Bracket and isolator MFT-FOX VI
- ④ Insulation
- ⑤ Fixing insulation
- ⑥ Profile MFT-CP T
- ⑦ Self drilling screw
- ⑧ Ventilation gap
- ⑨ Aluminum-bolt MFT-C BO
- ⑩ Clip MFT-C
- ⑫ Cladding

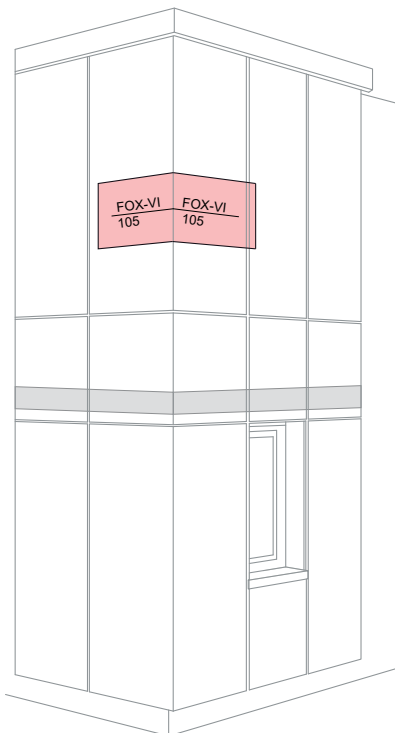

This is an interactive page! Click on the move-back button to jump back to the VIEW OF CLADDING.

MFT-FOX VI 106

Legend:

- ① Base material
- ② Anchor acc. to static
- ③ Bracket and isolator MFT-FOX VI
- ④ Insulation
- ⑤ Fixing insulation
- ⑥ Profile MFT-CP T
- ⑦ Self drilling screw
- ⑧ Ventilation gap
- ⑨ Aluminum-bolt MFT-C BO
- ⑩ Clip MFT-C
- ⑫ Cladding

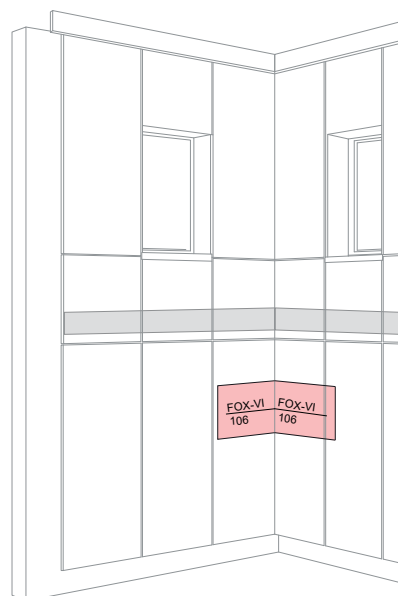
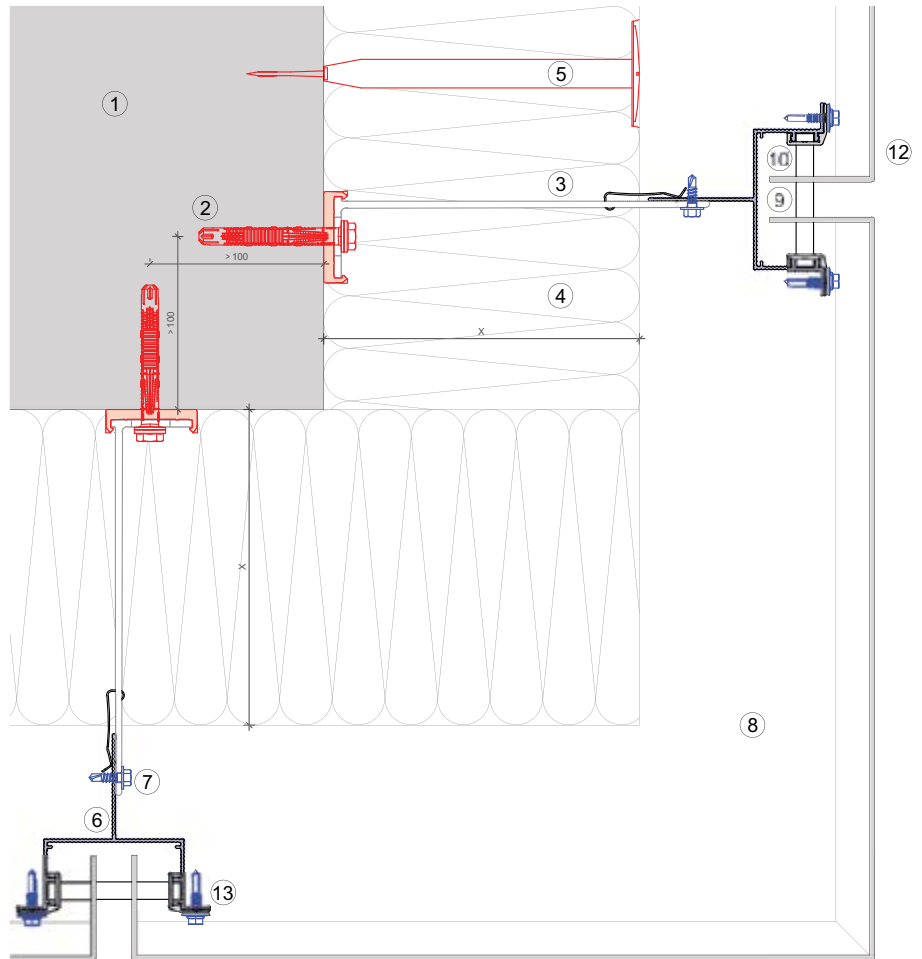

This is an interactive page! Click on the move-back button to jump back to the VIEW OF CLADDING.



MFT-FOX VI 107

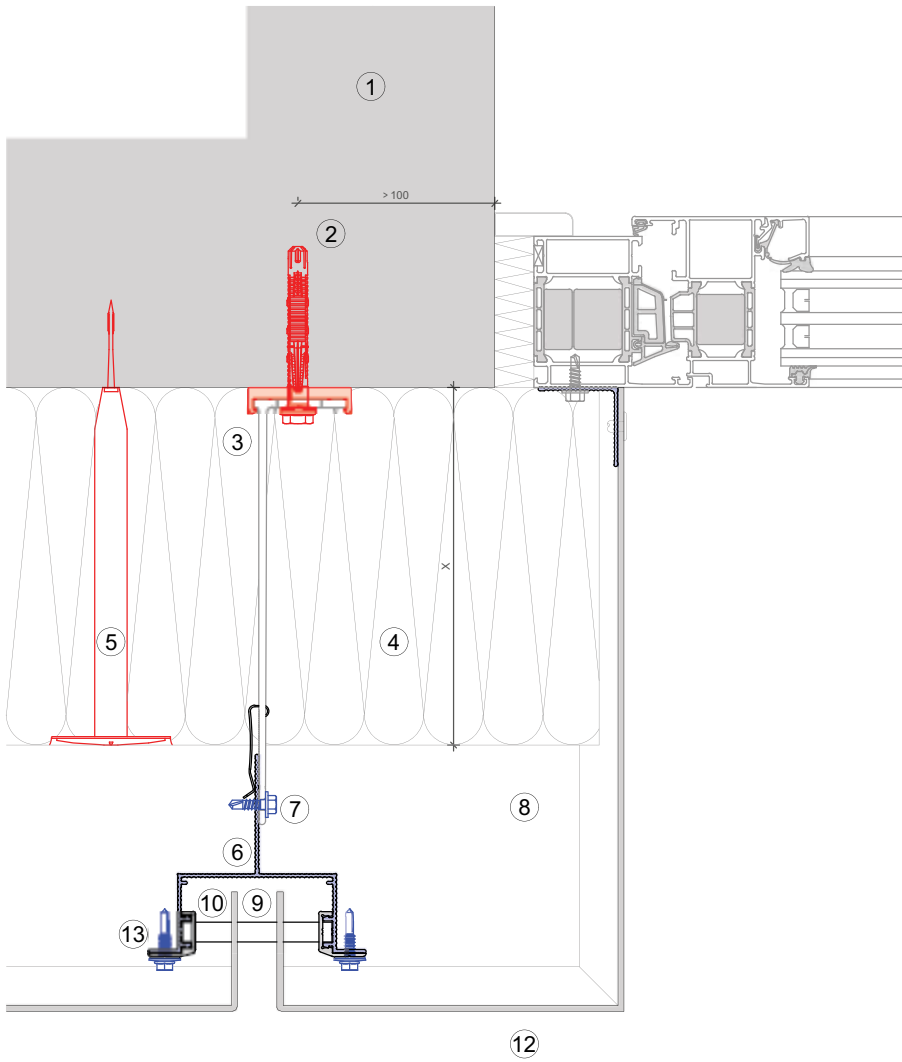

Legend:

- ① Base material
- ② Anchor acc. to static
- ③ Bracket and isolator MFT-FOX VI
- ④ Insulation
- ⑤ Fixing insulation
- ⑥ Profile MFT-CP T
- ⑦ Self drilling screw
- ⑧ Ventilation gap
- ⑨ Aluminum-bolt MFT-C BO
- ⑩ Clip MFT-C
- ⑫ Cladding

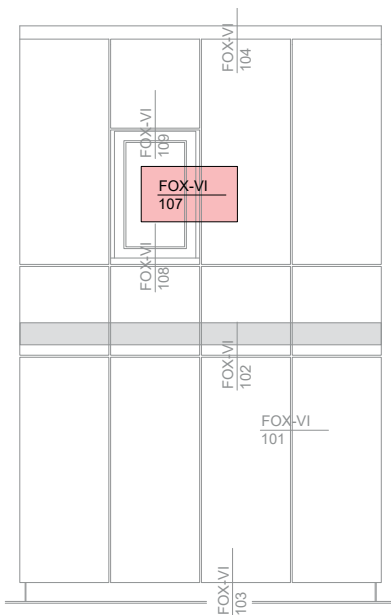

This is an interactive page! Click on the move-back button to jump back to the VIEW OF CLADDING.

MFT-FOX VI 108

Legend:

- ① Base material
- ② Anchor acc. to static
- ③ Bracket and isolator MFT-FOX VI
- ④ Insulation
- ⑤ Fixing insulation
- ⑥ Profile MFT-CP T
- ⑦ Self drilling screw
- ⑧ Ventilation gap
- ⑨ Aluminum-bolt MFT-C BO
- ⑩ Clip MFT-C
- ⑪ Fixing cladding
- ⑫ Cladding

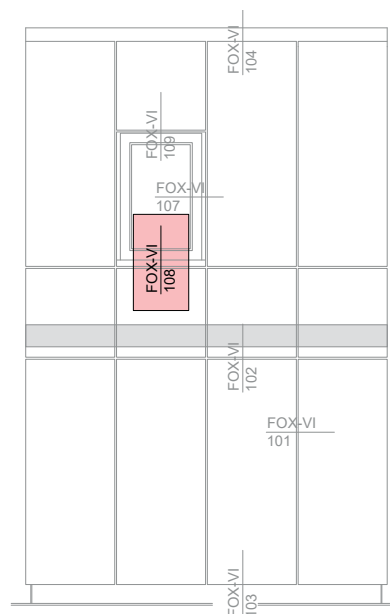
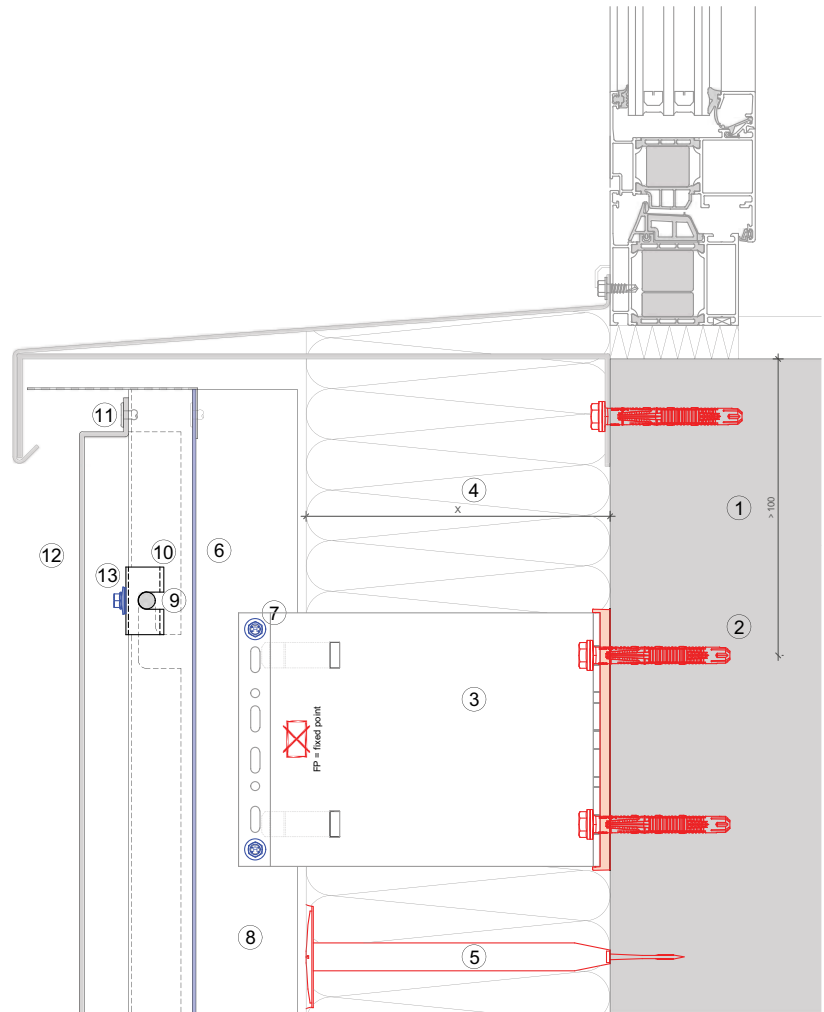

This is an interactive page! Click on the move-back button to jump back to the VIEW OF CLADDING.



MFT-FOX VI 109

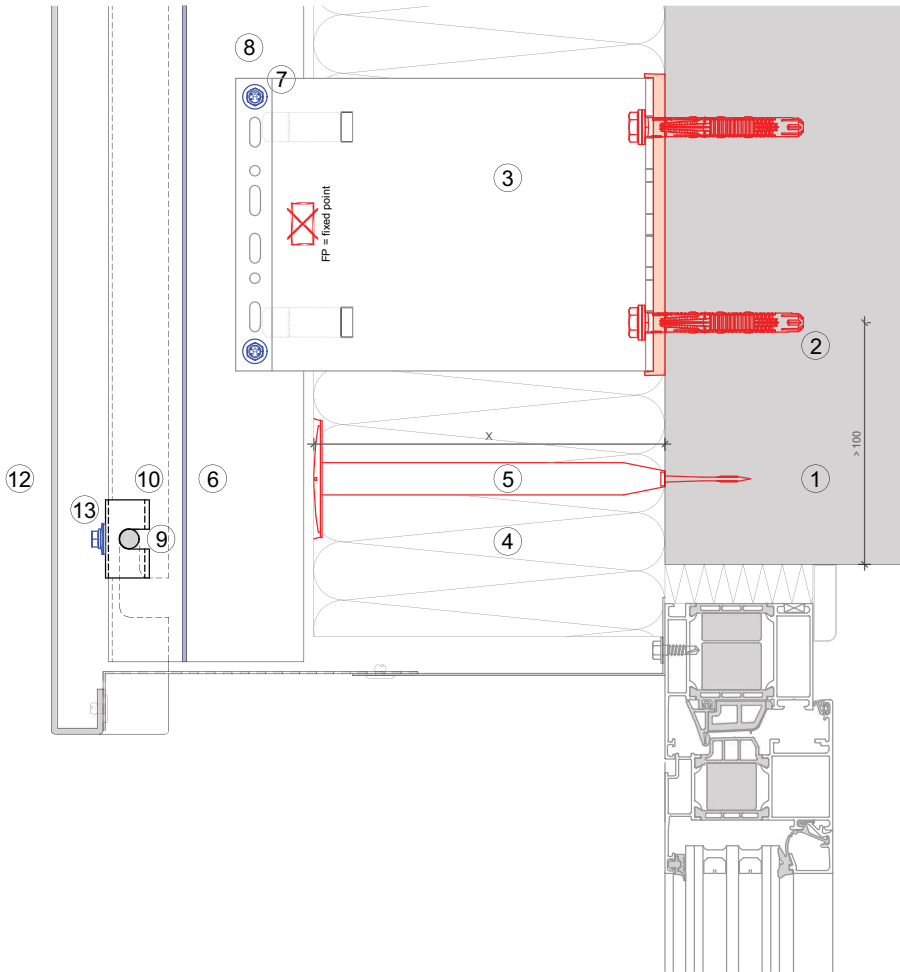

Legend:

- ① Base material
- ② Anchor acc. to static
- ③ Bracket and isolator MFT-FOX VI
- ④ Insulation
- ⑤ Fixing insulation
- ⑥ Profile MFT-CP T
- ⑦ Self drilling screw
- ⑧ Ventilation gap
- ⑨ Aluminum-bolt MFT-C BO
- ⑩ Clip MFT-C
- ⑪ Cladding
- ⑫ Cladding

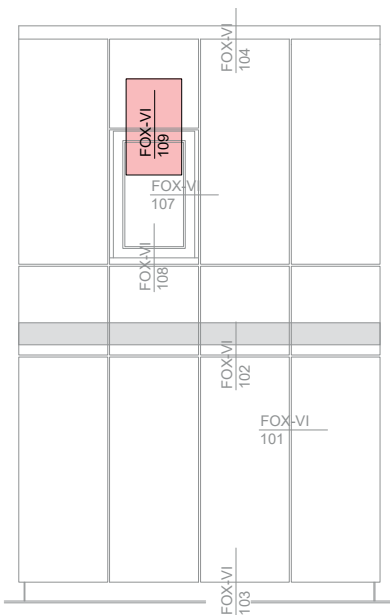

This is an interactive page! Click on the move-back button to jump back to the VIEW OF CLADDING.

MFT-FOX VI 109

Legend:

- ① Base material
- ② Anchor acc. to static
- ③ Bracket and isolator MFT-FOX VI
- ④ Insulation
- ⑤ Fixing insulation
- ⑥ Profile MFT-CP T
- ⑦ Self drilling screw
- ⑧ Ventilation gap
- ⑨ Aluminum-bolt MFT-C BO
- ⑩ Clip MFT-C
- ⑫ Cladding

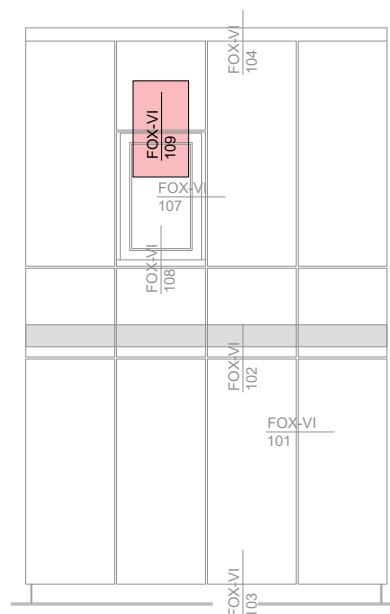
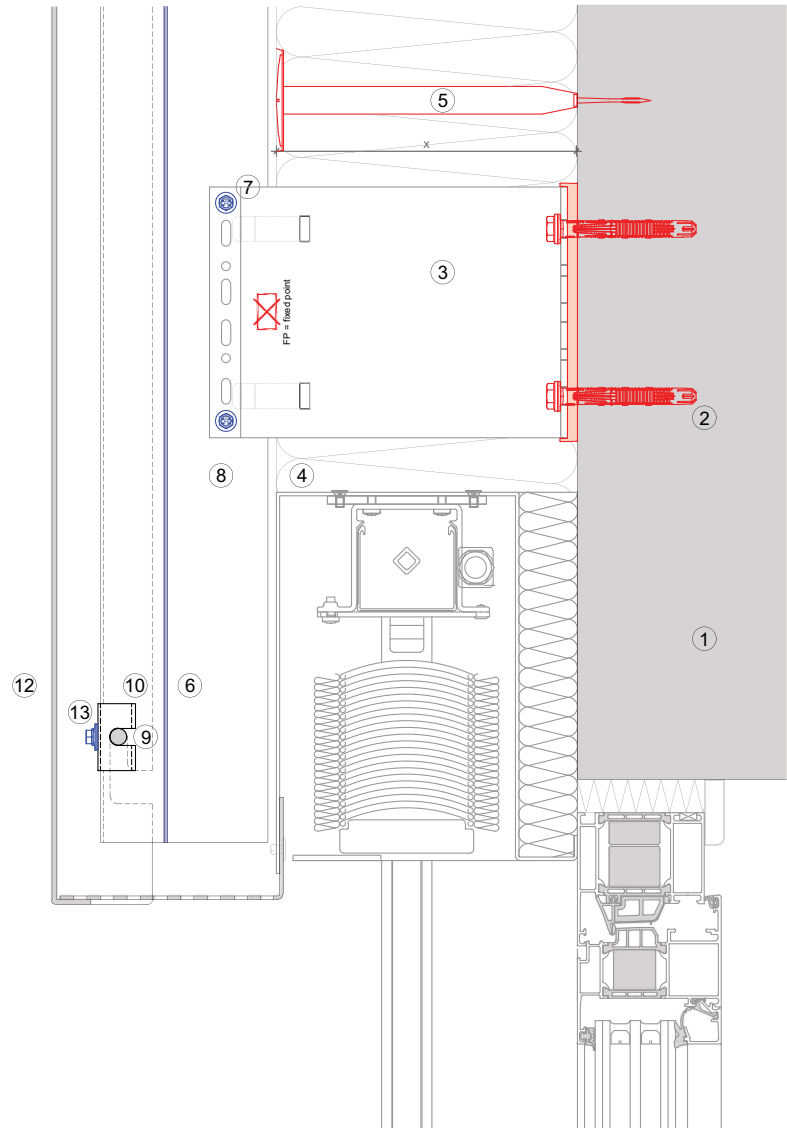

This is an interactive page! Click on the move-back button to jump back to the VIEW OF CLADDING.



BRACKETS RANGE

MFT-FOX VI Small

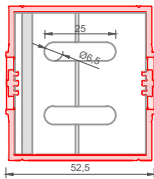
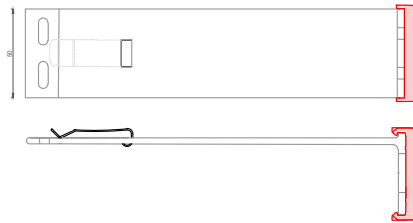

Direct fastening and Screws

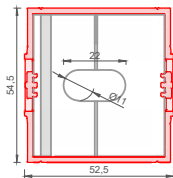

Anchors

Order description	Item No.	Length
DIRECT FASTENING and SCREWS D=6,5 mm		
MFT-FOX VI 40 S 6.5	2305768	40 mm
MFT-FOX VI 60 S 6.5	2305769	60 mm
MFT-FOX VI 80 S 6.5	2305892	80 mm
MFT-FOX VI 100 S 6.5	2305893	100 mm
MFT-FOX VI 120 S 6.5	2305894	120 mm
MFT-FOX VI 140 S 6.5	2305895	140 mm
MFT-FOX VI 160 S 6.5	2305896	160 mm
MFT-FOX VI 180 S 6.5	2305891	180 mm
MFT-FOX VI 200 S 6.5	2305890	200 mm
MFT-FOX VI 220 S 6.5	2305889	220 mm
MFT-FOX VI 240 S 6.5	2305888	240 mm
MFT-FOX VI 260 S 6.5	2305887	260 mm
MFT-FOX VI 280 S 6.5	2305886	280 mm
MFT-FOX VI 300 S 6.5	2305885	300 mm
ANCHORS D=11 mm		
MFT-FOX VI 40 S 11	2305884	40 mm
MFT-FOX VI 60 S 11	2305883	60 mm
MFT-FOX VI 80 S 11	2305882	80 mm
MFT-FOX VI 100 S 11	2305881	100 mm
MFT-FOX VI 120 S 11	2305880	120 mm
MFT-FOX VI 140 S 11	2305897	140 mm
MFT-FOX VI 160 S 11	2305898	160 mm
MFT-FOX VI 180 S 11	2305899	180 mm
MFT-FOX VI 200 S 11	2305900	200 mm
MFT-FOX VI 220 S 11	2305901	220 mm
MFT-FOX VI 240 S 11	2305902	240 mm
MFT-FOX VI 260 S 11	2305903	260 mm
MFT-FOX VI 280 S 11	2305904	280 mm
MFT-FOX VI 300 S 11	2305905	300 mm

The length shown includes the isolator thickness.

BRACKETS RANGE

MFT-FOX VI Medium

Order description	Item No.	Length
DIRECT FASTENING, SCREWS D=6,5 mm and ANCHORS D=11 mm		
MFT-FOX VI 40 M 6.5 / 11	2305984	40 mm
MFT-FOX VI 60 M 6.5 / 11	2305983	60 mm
MFT-FOX VI 80 M 6.5 / 11	2305982	80 mm
MFT-FOX VI 100 M 6.5 / 11	2305981	100 mm
MFT-FOX VI 120 M 6.5 / 11	2305980	120 mm
MFT-FOX VI 140 M 6.5 / 11	2305979	140 mm
MFT-FOX VI 160 M 6.5 / 11	2305978	160 mm
MFT-FOX VI 180 M 6.5 / 11	2305977	180 mm
MFT-FOX VI 200 M 6.5 / 11	2305976	200 mm
MFT-FOX VI 220 M 6.5 / 11	2305975	220 mm
MFT-FOX VI 240 M 6.5 / 11	2305974	240 mm
MFT-FOX VI 260 M 6.5 / 11	2305973	260 mm
MFT-FOX VI 280 M 6.5 / 11	2305972	280 mm
MFT-FOX VI 300 M 6.5 / 11	2305971	300 mm

The length shown includes the isolator thickness.

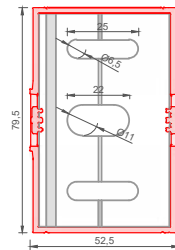
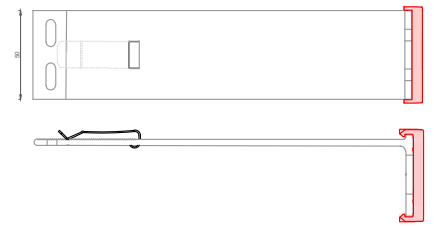

Direct fastening
Screws and
Anchors

BRACKETS RANGE

MFT-FOX VI Large

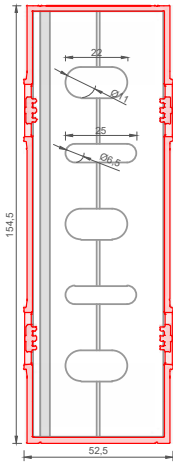
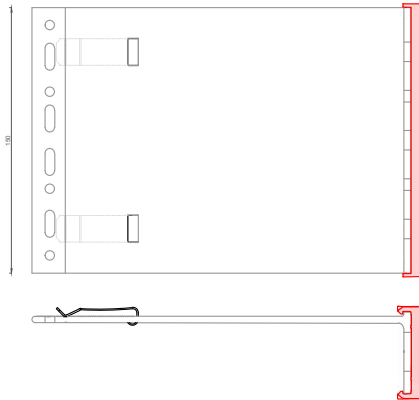

Direct fastening
Screws and
Anchors

Order description	Item No.	Length
DIRECT FASTENING, SCREWS D=6,5 mm and ANCHORS D=11 mm		
MFT-FOX VI 40 L 6.5 / 11	2305950	40 mm
MFT-FOX VI 60 L 6.5 / 11	2305949	60 mm
MFT-FOX VI 80 L 6.5 / 11	2305948	80 mm
MFT-FOX VI 100 L 6.5 / 11	2305947	100 mm
MFT-FOX VI 120 L 6.5 / 11	2305946	120 mm
MFT-FOX VI 140 L 6.5 / 11	2305945	140 mm
MFT-FOX VI 160 L 6.5 / 11	2305944	160 mm
MFT-FOX VI 180 L 6.5 / 11	2305943	180 mm
MFT-FOX VI 200 L 6.5 / 11	2305942	200 mm
MFT-FOX VI 220 L 6.5 / 11	2305941	220 mm
MFT-FOX VI 240 L 6.5 / 11	2305940	240 mm
MFT-FOX VI 260 L 6.5 / 11	2305939	260 mm
MFT-FOX VI 280 L 6.5 / 11	2305938	280 mm
MFT-FOX VI 300 L 6.5 / 11	2305937	300 mm

The length shown includes the isolator thickness.

BRACKET PROFILE ADJUSTMENT

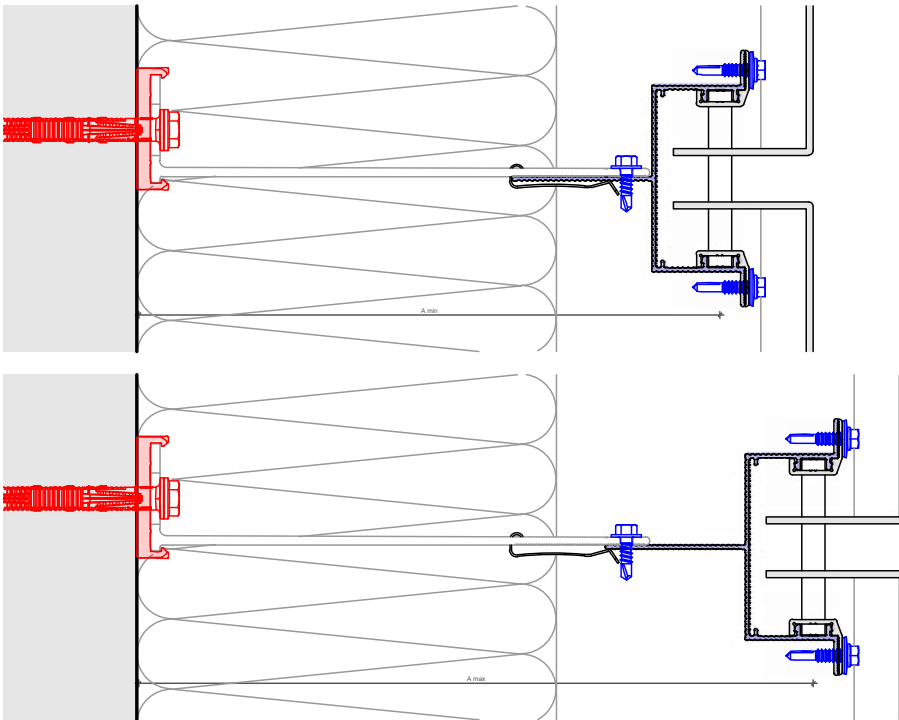

Profiles	MFT-CP-T 40x80x1,9 6 m	
Brackets	A min	A max
MFT-FOX VI 40 S/M/L 6,5/11	105	109,25
MFT-FOX VI 60 S/M/L 6,5/11	105	129,25
MFT-FOX VI 80 S/M/L 6,5/11	110	149,25
MFT-FOX VI 100 S/M/L 6,5/11	130	169,25
MFT-FOX VI 120 S/M/L 6,5/11	150	189,25
MFT-FOX VI 140 S/M/L 6,5/11	170	209,25
MFT-FOX VI 160 S/M/L 6,5/11	190	229,25
MFT-FOX VI 180 S/M/L 6,5/11	210	249,25
MFT-FOX VI 200 S/M/L 6,5/11	230	269,25
MFT-FOX VI 220 S/M/L 6,5/11	250	289,25
MFT-FOX VI 240 S/M/L 6,5/11	270	309,25
MFT-FOX VI 260 S/M/L 6,5/11	290	329,25
MFT-FOX VI 280 S/M/L 6,5/11	310	349,25
MFT-FOX VI 300 S/M/L 6,5/11	330	369,25

* The distance shown is valid for profile of 1,8 mm.

PRODUCTS RANGE

Bracket fastener

HUS-HR



HRD-H



HST-R



HSA-R



HIT-HY 270



HIT-HY 200-A



S-MP 53S

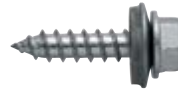

S-MD 51S / S-MD 53S / S-MD 55S



Direct fastening:

Powder-actuated tool



Universal nail X-CR P8



DX cartridge 6.8/11 M10



Brackets

MFT-FOX VI Small



MFT-FOX VI Medium



MFT-FOX VI Large



This is an interactive page! Click on the move-back button to jump back to the CONTENT AND OVERVIEW.

PRODUCTS RANGE

Profiles

MFT-L



MFT-CP T



Profile to bracket fastener

S-AD 01S



Other Accessories

MFT-C



MFT-C BO



Insulation fasteners

Insulation fasteners

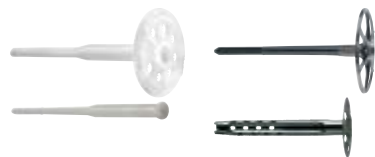



Hilti Corporation
9494 Schaan Liechtenstein
P +423-234 2111

www.facebook.com/hiltigroup
www.hilti.group