



MFT-FOX-HT-1L- RIVETS-SCREWS

Hilti facade system



CONTENT AND OVERVIEW

Panels	3
Application and Description	4
System Drawings	5-17
Brackets Range	
MFT-FOX HT Medium	18
MFT-FOX HT Large	19
Bracket Profile Adjustment	20
Products Range	21-22

MFT-FOX-HT-1L-rivets-screws



This is an interactive page! Click on the move-back button to jump back to the CONTENT AND OVERVIEW.





APPLICATION AND DESCRIPTION

MFT-FOX-HT-1L-rivets-screws

The system consists of thermal free wall brackets and profiles, and is specifically designed for horizontal substructures in ventilated facades. Due to the vertical fastening of the brackets an optimal load transfer to the base material can be realized. Wall brackets are supplied with powder coated base plate, according to the method of installation to the base material - anchors, screws and direct fastening - with different hole geometries in the base plate (available hole geometries are shown in the catalogue, on HOL or on the following pages).

In addition to the pre-mounted connection screw the bracket offers an easy and efficient way of mounting. Fix and flexible points are not required as the thermal expansion of the profile will be covered by the flexibility of the bracket. The bracket offers a quick and safe fastening; wrong installed brackets are a thing of the past.

An additional washer allows a fastening according to Eurocode with vertical adjustment of the bracket (anchor and direct fastening).

Advantages:

- The design of fix and flexible points is not required anymore
- Bracket length from 140 mm to 320 mm
- Avoiding contact corrosion by powder coated base plate
- 40 mm adjustment capability of the profiles in the wall brackets
- Pre-mounted fastening screw in A4 material
- Brackets can be mounted using a range of methods - anchors, screws or direct fastening
- Substructures can be designed with PROFIS Fagade to generate technically-sound and economically-optimized solutions
- Can be used with all common cladding materials

VIEW OF CLADDING

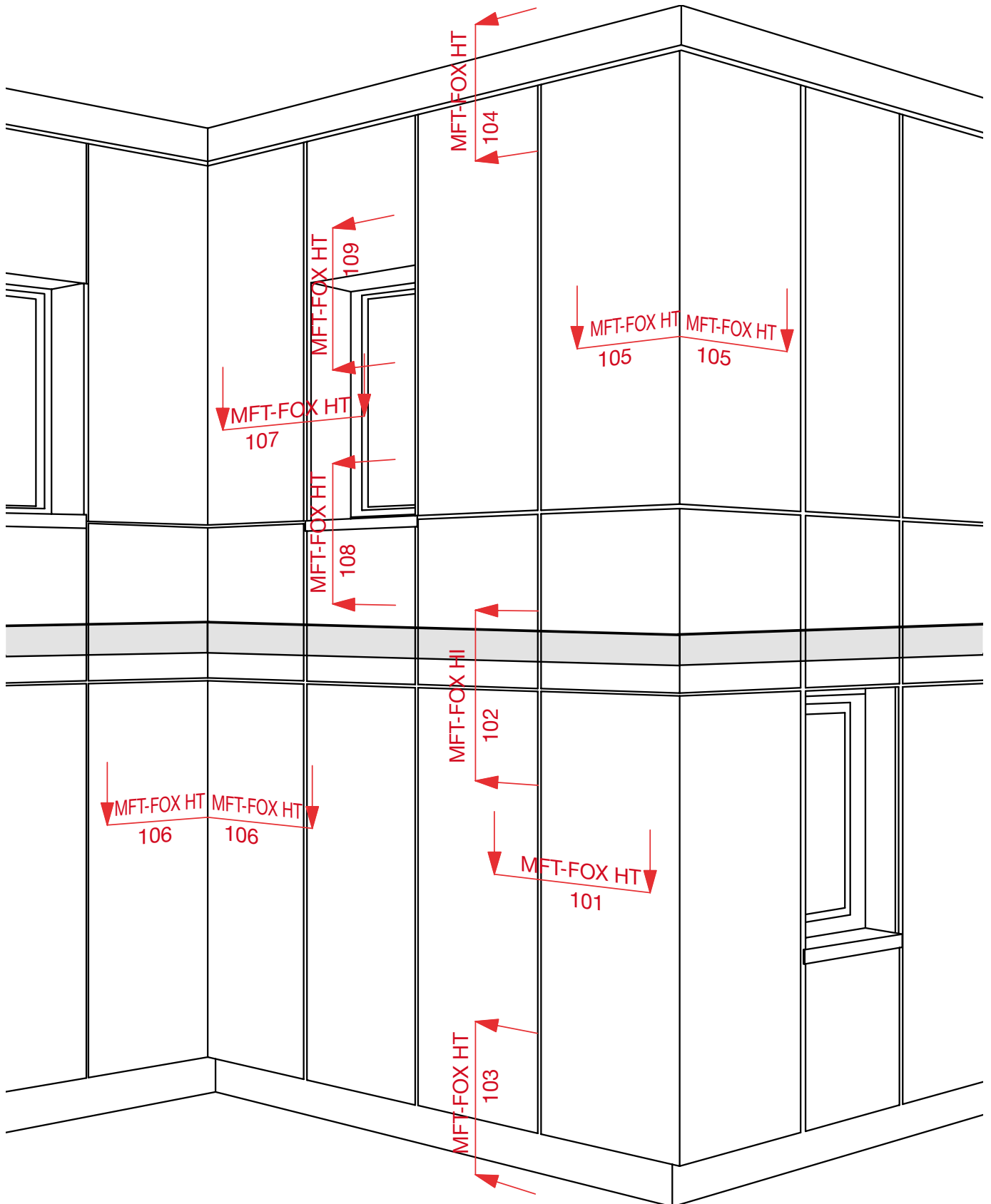

This is an interactive page! By clicking on a system part you get directed to the respective detail page.
Click on the move-back button to jump back to the CONTENT AND OVERVIEW.

MFT-FOX HT 101

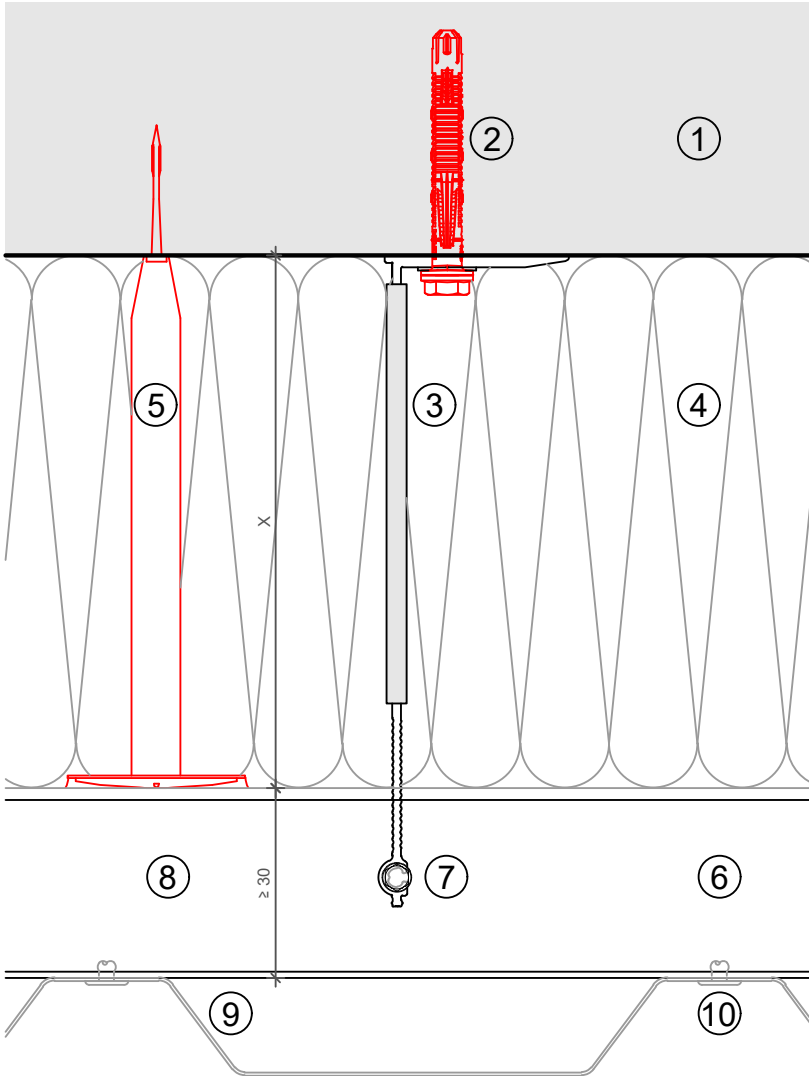

Legend:

- ① Base material
- ② Anchor acc. to static
- ③ Bracket and isolator
- ④ Insulation
- ⑤ Fixing insulation
- ⑥ Profile
- ⑦ Self drilling screw
- ⑧ Ventilation gap
- ⑨ Cladding
- ⑩ Fixing cladding

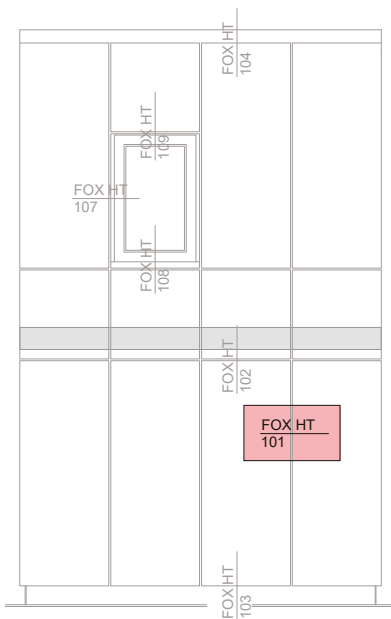

This is an interactive page! Click on the move-back button to jump back to the VIEW OF CLADDING.

MFT-FOX HT 102

Legend:

- ① Base material
- ② Anchor acc. to static
- ③ Bracket and isolator
- ④ Insulation
- ⑤ Fixing insulation
- ⑥ Profile
- ⑦ Self drilling screw
- ⑧ Ventilation gap
- ⑨ Cladding
- ⑩ Fixing cladding

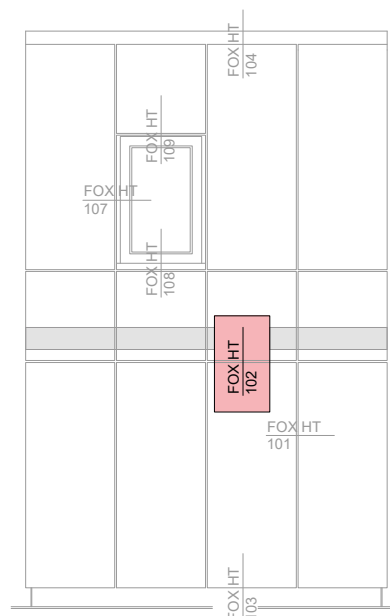
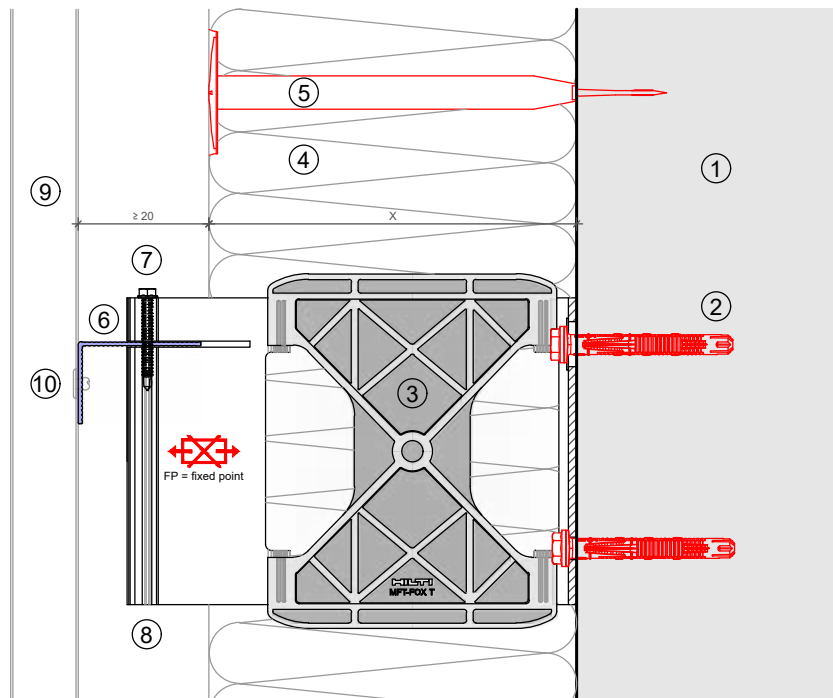

This is an interactive page! Click on the move-back button to jump back to the VIEW OF CLADDING.



MFT-FOX HT 103

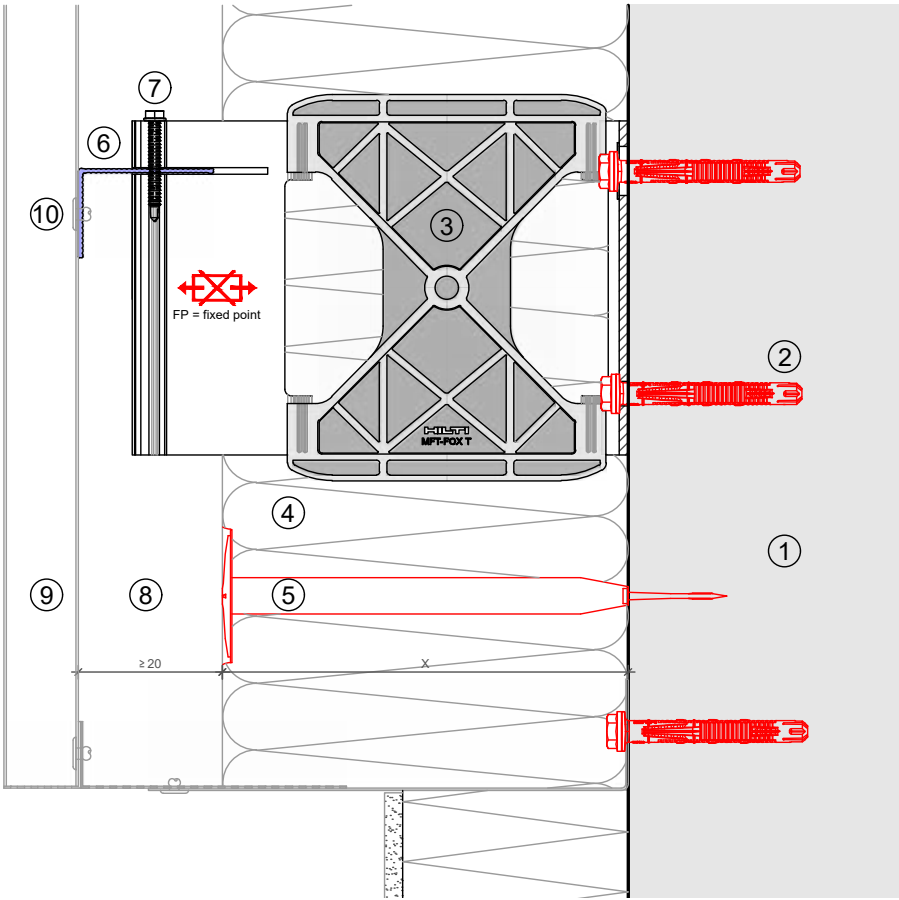

Legend:

- ① Base material
- ② Anchor acc. to static
- ③ Bracket and isolator
- ④ Insulation
- ⑤ Fixing insulation
- ⑥ Profile
- ⑦ Self drilling screw
- ⑧ Ventilation gap
- ⑨ Cladding
- ⑩ Fixing cladding

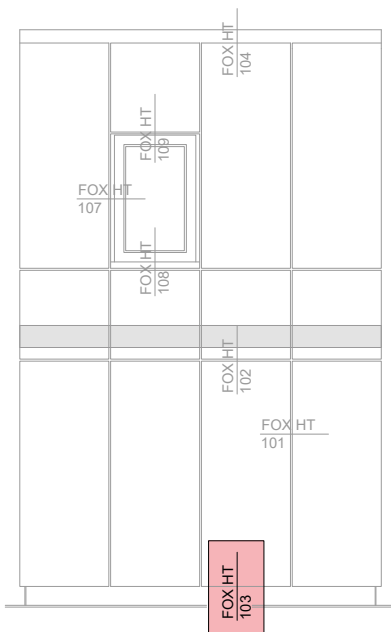

This is an interactive page! Click on the move-back button to jump back to the VIEW OF CLADDING.

MFT-FOX HT 104

Legend:

- ① Base material
- ② Anchor acc. to static
- ③ Bracket and isolator
- ④ Insulation
- ⑤ Fixing insulation
- ⑥ Profile
- ⑦ Self drilling screw
- ⑧ Ventilation gap
- ⑨ Cladding
- ⑩ Fixing cladding

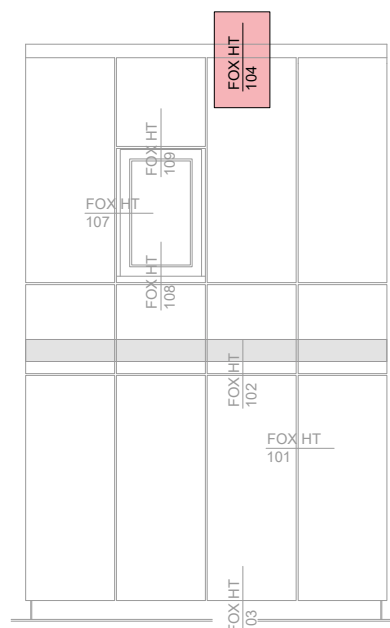
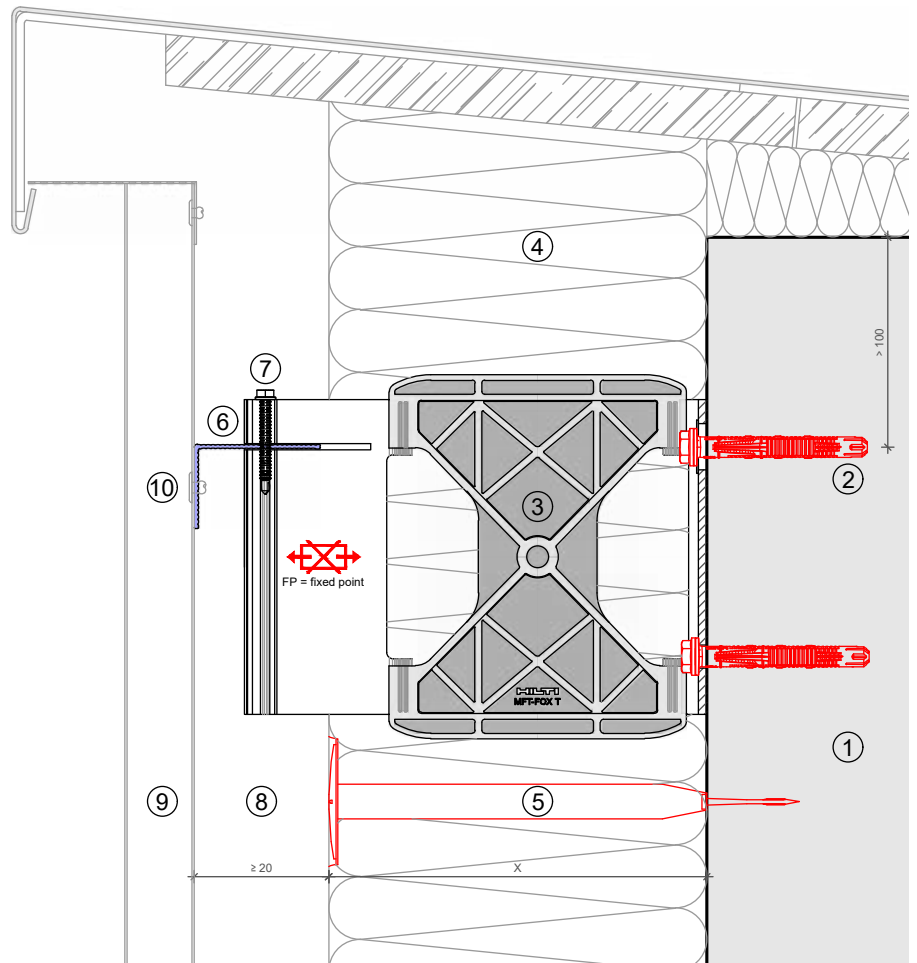

This is an interactive page! Click on the move-back button to jump back to the VIEW OF CLADDING.



MFT-FOX HT 105

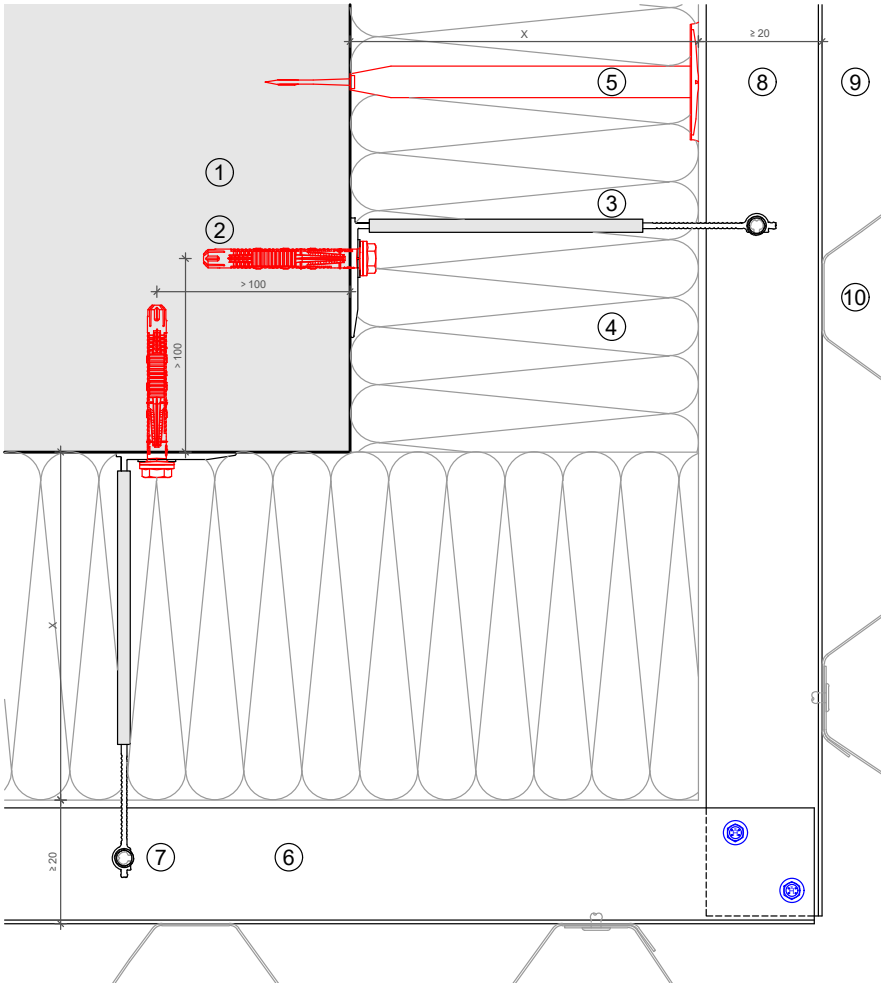

Legend:

- ① Base material
- ② Anchor acc. to static
- ③ Bracket and isolator
- ④ Insulation
- ⑤ Fixing insulation
- ⑥ Profile
- ⑦ Self drilling screw
- ⑧ Ventilation gap
- ⑨ Cladding
- ⑩ Fixing cladding

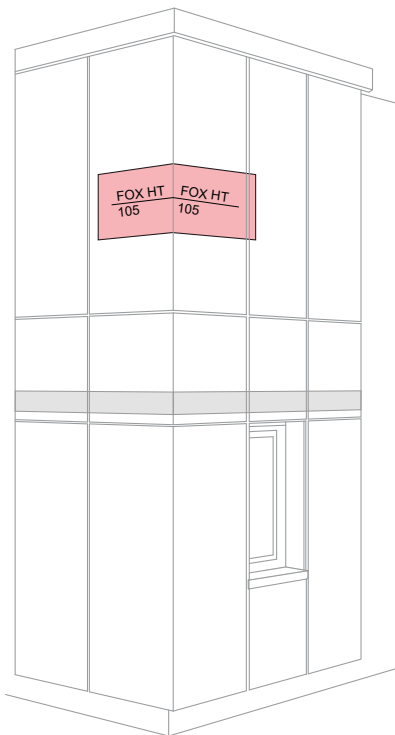

This is an interactive page! Click on the move-back button to jump back to the VIEW OF CLADDING.

MFT-FOX HT 106

Legend:

- ① Base material
- ② Anchor acc. to static
- ③ Bracket and isolator
- ④ Insulation
- ⑤ Fixing insulation
- ⑥ Profile
- ⑦ Self drilling screw
- ⑧ Ventilation gap
- ⑨ Cladding
- ⑩ Fixing cladding

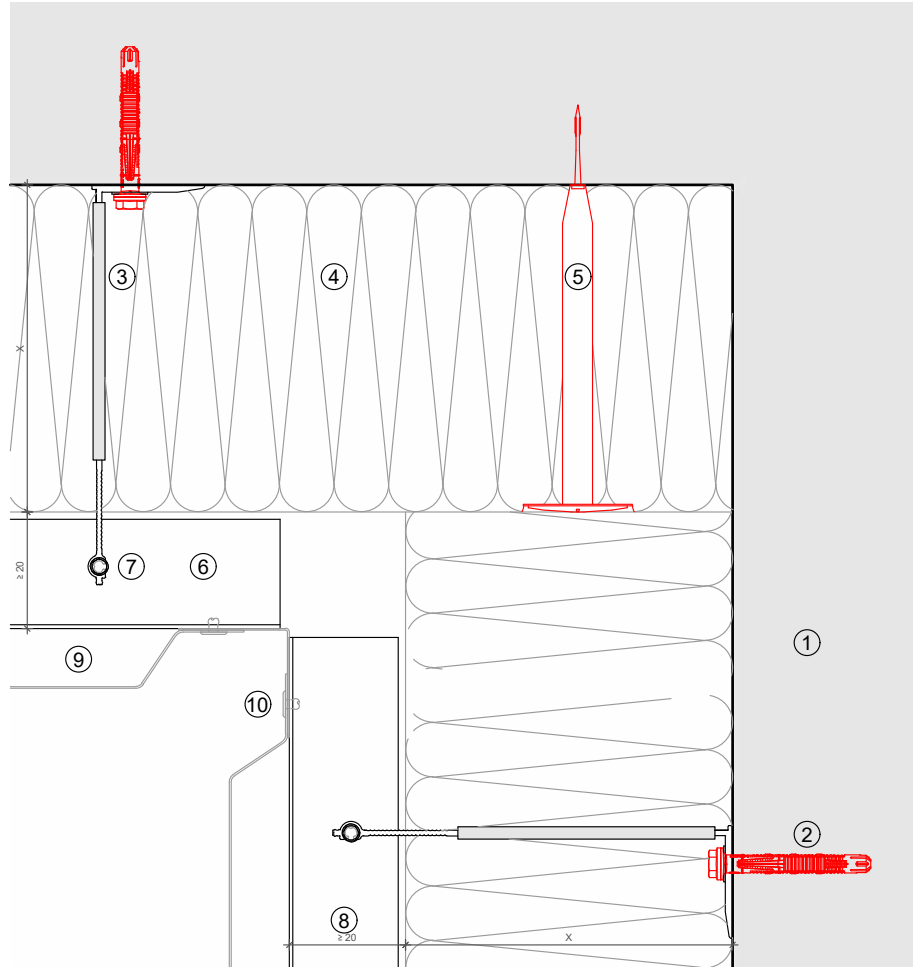

This is an interactive page! Click on the move-back button to jump back to the VIEW OF CLADDING.



MFT-FOX HT 107

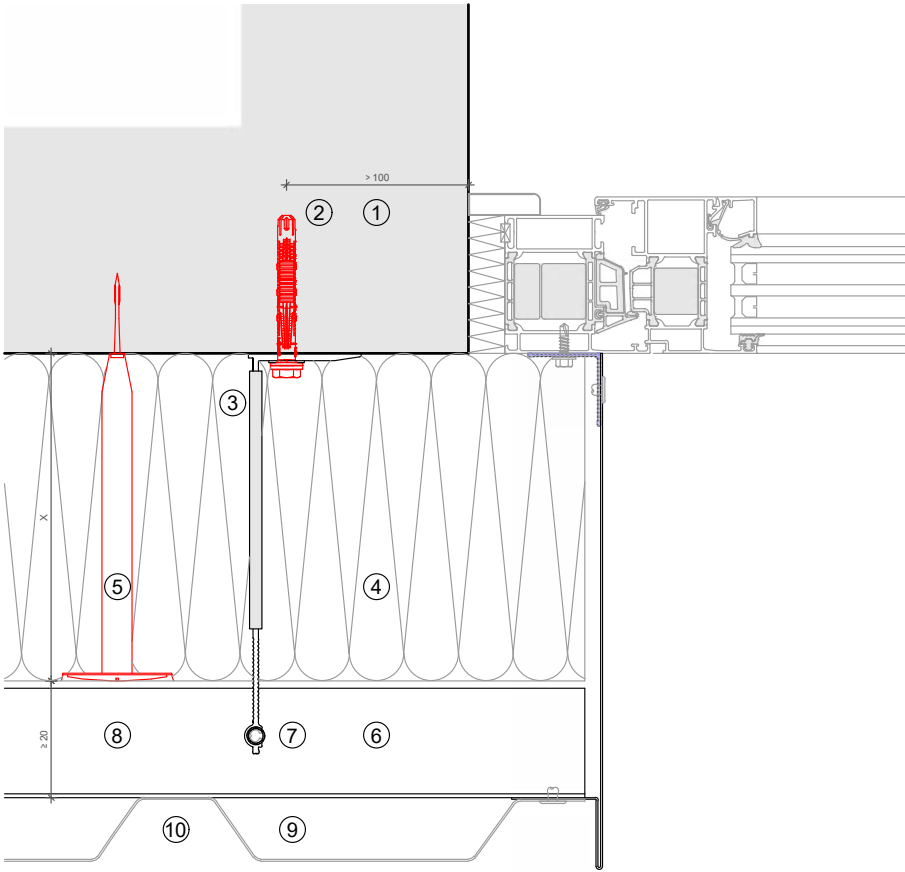

Legend:

- ① Base material
- ② Anchor acc. to static
- ③ Bracket and isolator
- ④ Insulation
- ⑤ Fixing insulation
- ⑥ Profile
- ⑦ Self drilling screw
- ⑧ Ventilation gap
- ⑨ Cladding
- ⑩ Fixing cladding

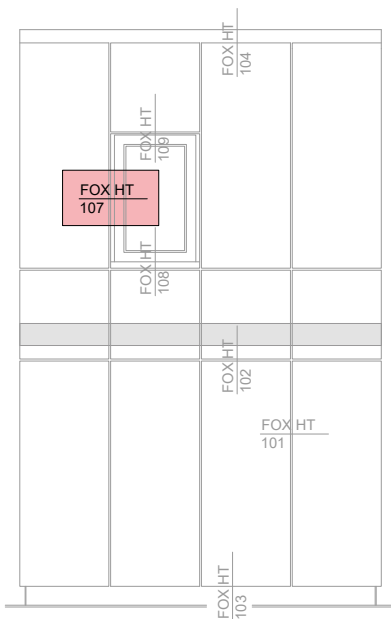

This is an interactive page! Click on the move-back button to jump back to the VIEW OF CLADDING.

MFT-FOX HT 107

Legend:

- ① Base material
- ② Anchor acc. to static
- ③ Bracket and isolator
- ④ Insulation
- ⑤ Fixing insulation
- ⑥ Profile
- ⑦ Self drilling screw
- ⑧ Ventilation gap
- ⑨ Cladding
- ⑩ Fixing cladding

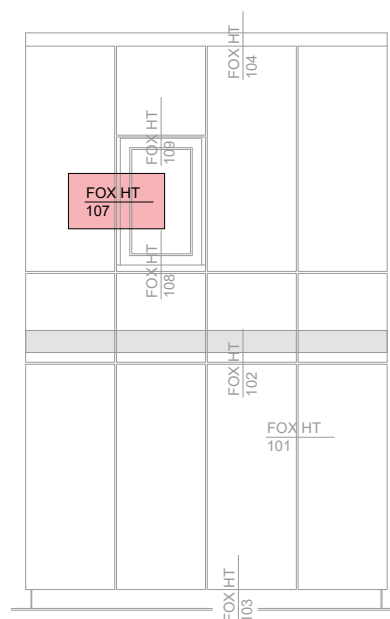
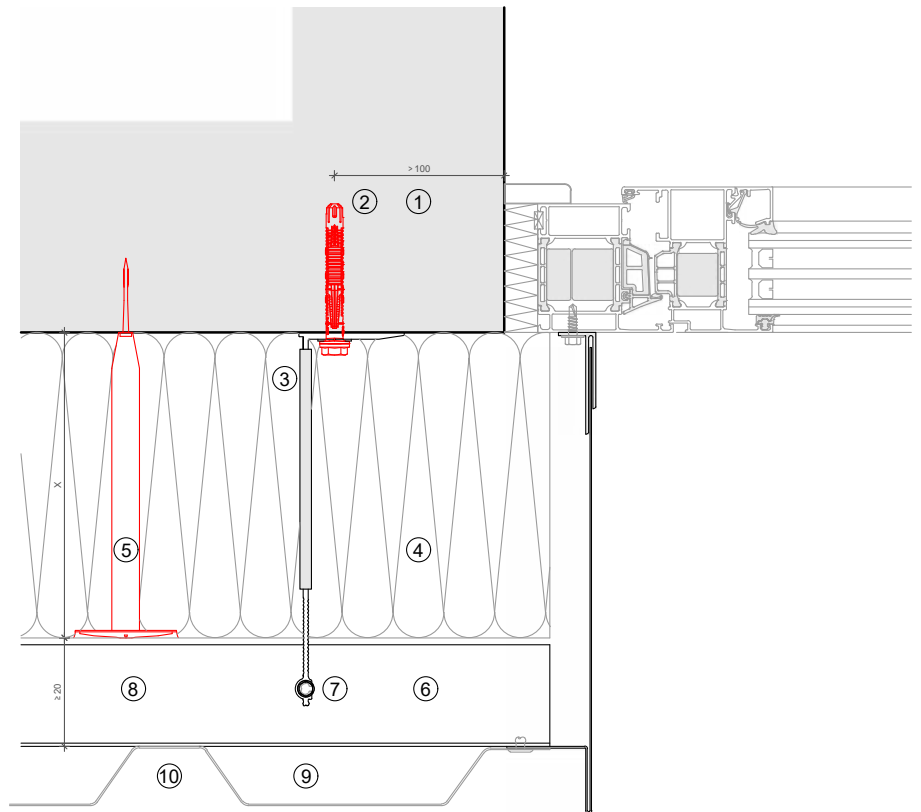

This is an interactive page! Click on the move-back button to jump back to the VIEW OF CLADDING.

MFT-FOX HT 108

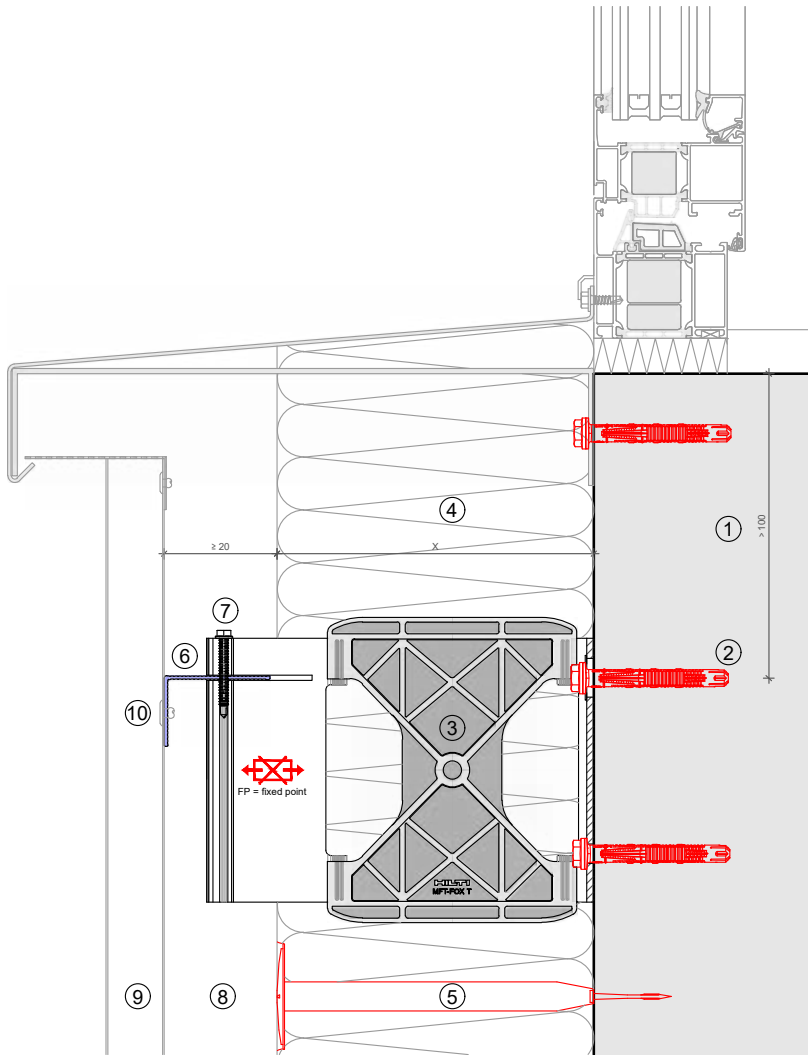

Legend:

- ① Base material
- ② Anchor acc. to static
- ③ Bracket and isolator
- ④ Insulation
- ⑤ Fixing insulation
- ⑥ Profile
- ⑦ Self drilling screw
- ⑧ Ventilation gap
- ⑨ Cladding
- ⑩ Fixing cladding

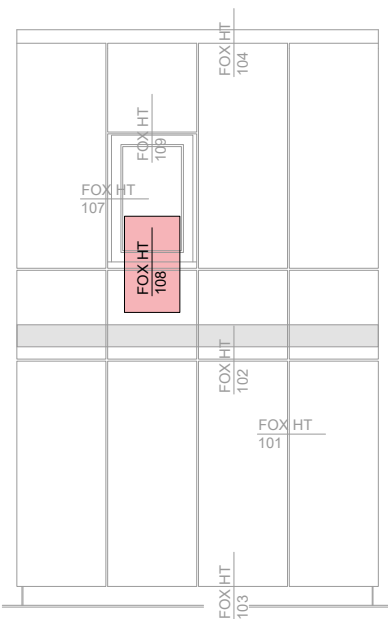

This is an interactive page! Click on the move-back button to jump back to the VIEW OF CLADDING.

MFT-FOX HT 109

Legend:

- ① Base material
- ② Anchor acc. to static
- ③ Bracket and isolator
- ④ Insulation
- ⑤ Fixing insulation
- ⑥ Profile
- ⑦ Self drilling screw
- ⑧ Ventilation gap
- ⑨ Cladding
- ⑩ Fixing cladding

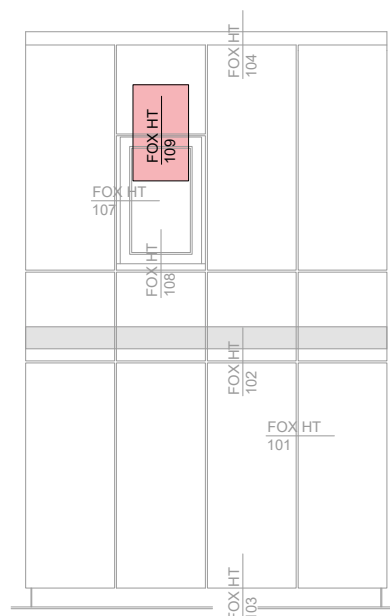
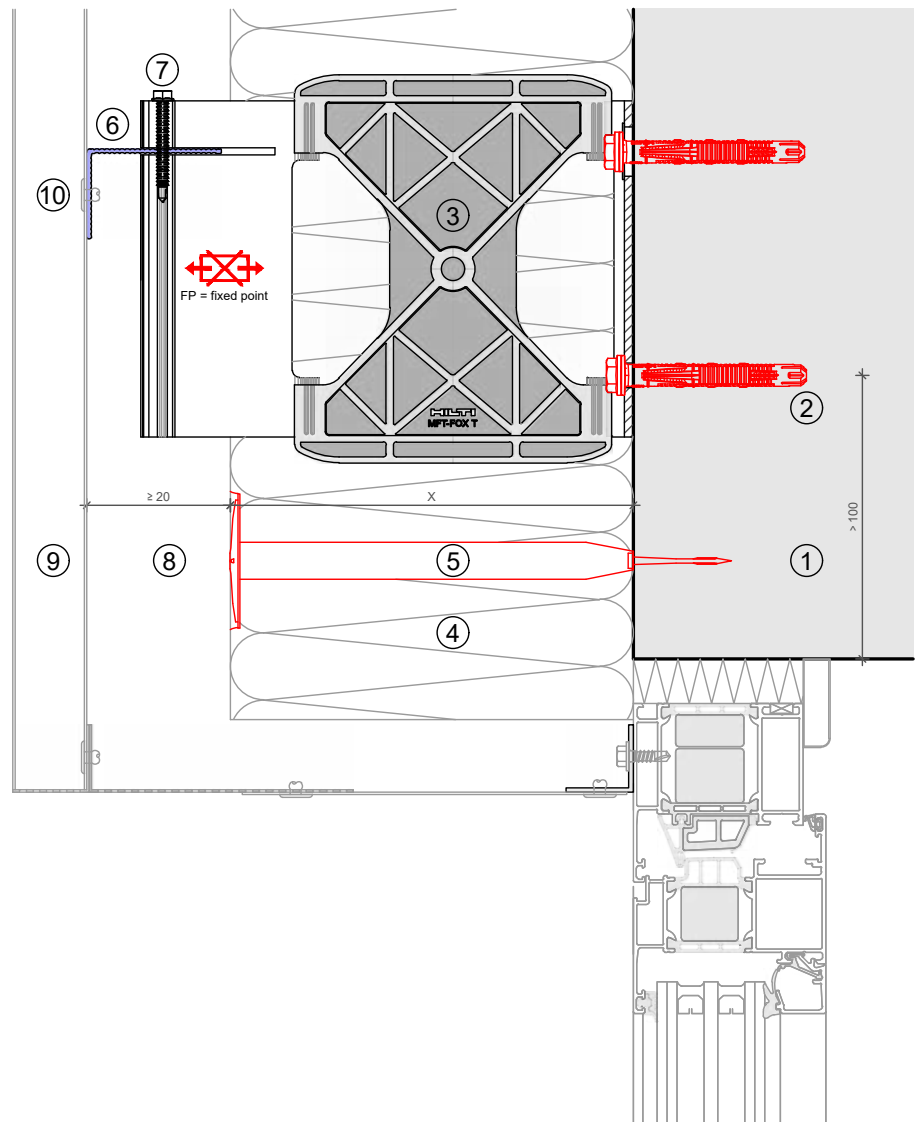

This is an interactive page! Click on the move-back button to jump back to the VIEW OF CLADDING.



MFT-FOX HT 109

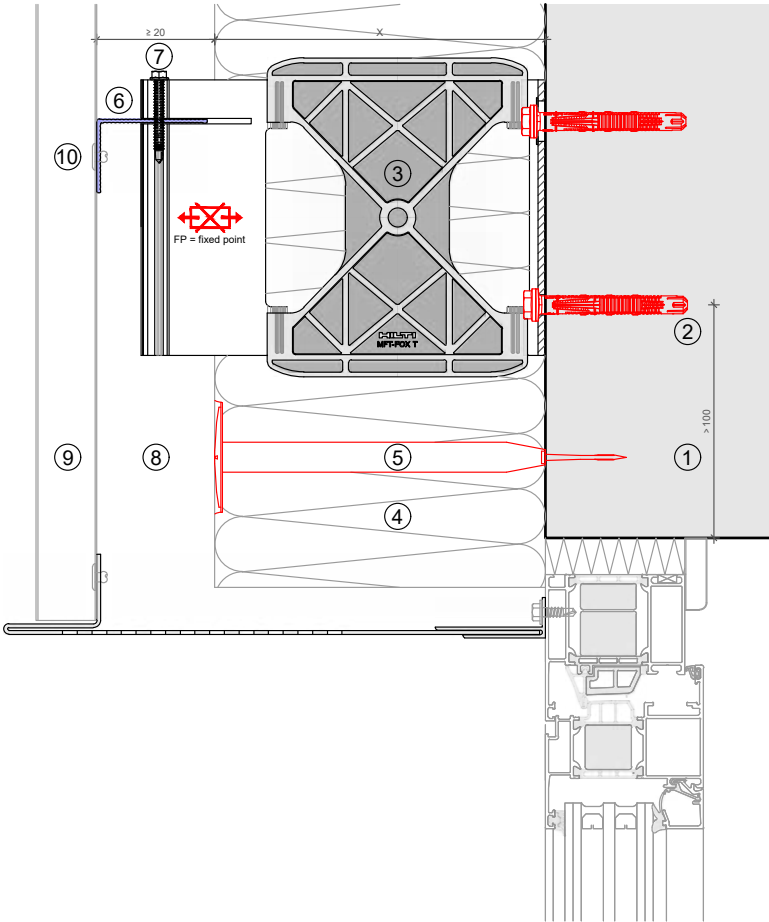

Legend:

- ① Base material
- ② Anchor acc. to static
- ③ Bracket and isolator
- ④ Insulation
- ⑤ Fixing insulation
- ⑥ Profile
- ⑦ Self drilling screw
- ⑧ Ventilation gap
- ⑨ Cladding
- ⑩ Fixing cladding

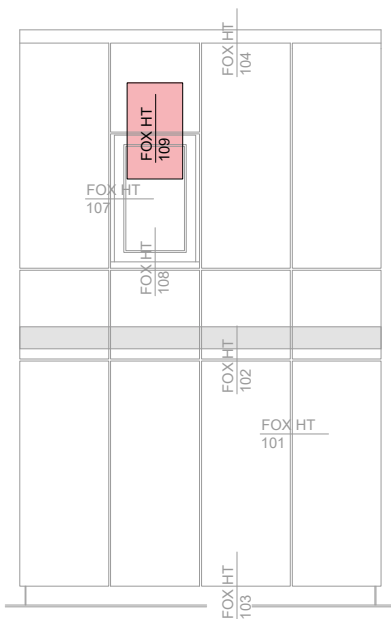

This is an interactive page! Click on the move-back button to jump back to the VIEW OF CLADDING.

MFT-FOX HT 109

Legend:

- ① Base material
- ② Anchor acc. to static
- ③ Bracket and isolator
- ④ Insulation
- ⑤ Fixing insulation
- ⑥ Profile
- ⑦ Self drilling screw
- ⑧ Ventilation gap
- ⑨ Cladding
- ⑩ Fixing cladding

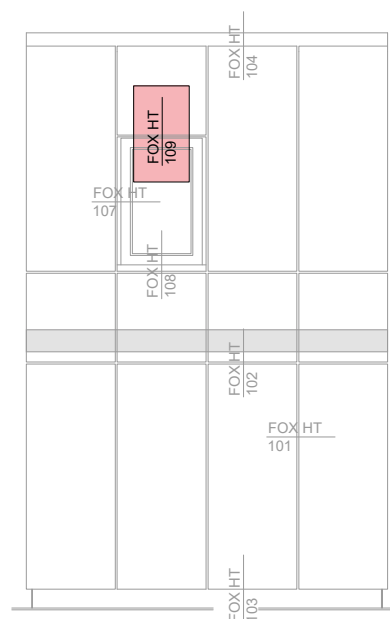
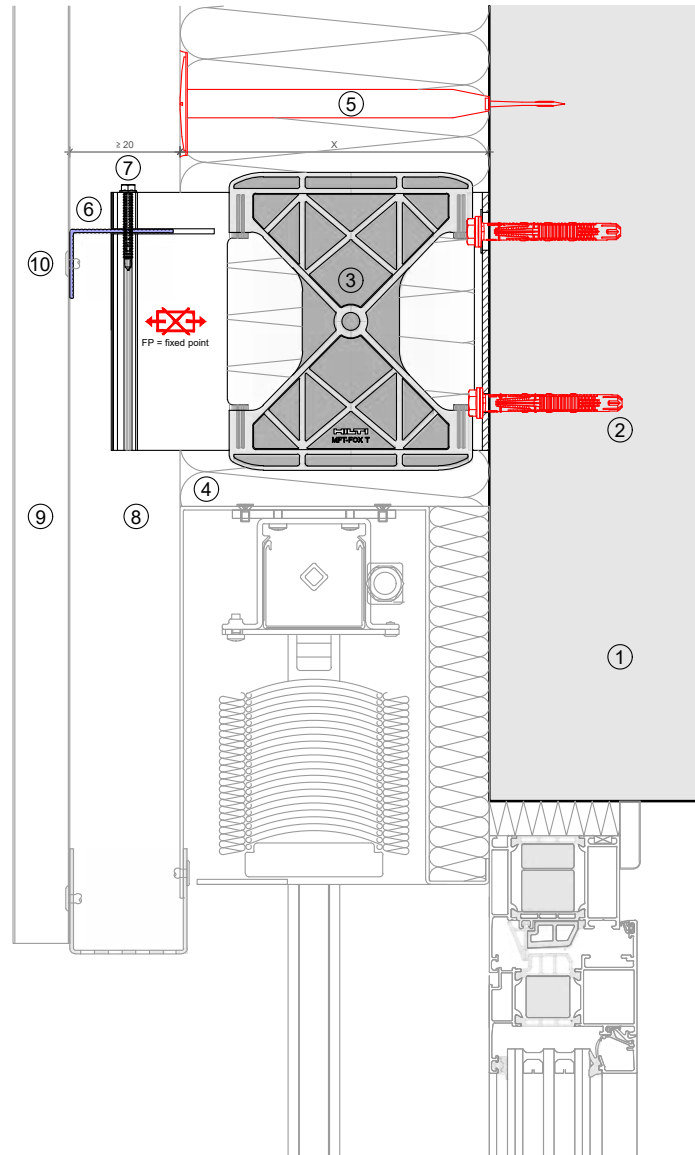

This is an interactive page! Click on the move-back button to jump back to the VIEW OF CLADDING.



BRACKETS RANGE

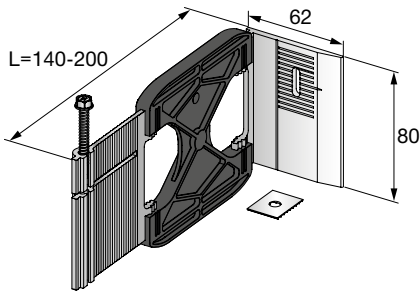

MFT-FOX HT Medium

Order Description	Item No.	Length
DIRECT FASTENING D=5 mm		
MFT-FOX HT 140 M 5	2096993	140 mm
MFT-FOX HT 160 M 5	2096996	160 mm
MFT-FOX HT 180 M 5	2096999	180 mm
MFT-FOX HT 200 M 5	2097002	200 mm
SCREWS D=6,5 mm		
MFT-FOX HT 140 M 6,5	2096994	140 mm
MFT-FOX HT 160 M 6,5	2096997	160 mm
MFT-FOX HT 180 M 6,5	2097000	180 mm
MFT-FOX HT 200 M 6,5	2097003	200 mm
ANCHORS D=11 mm		
MFT-FOX HT 140 M 11	2096995	140 mm
MFT-FOX HT 160 M 11	2096998	160 mm
MFT-FOX HT 180 M 11	2097001	180 mm
MFT-FOX HT 200 M 11	2097004	200 mm

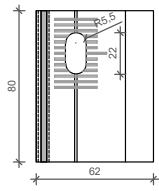

Anchor

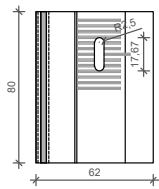

Direct fastening

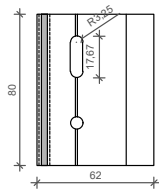

Screw fastening

BRACKETS RANGE

MFT-FOX HT Large

Order Description	Item No.	Length
DIRECT FASTENING D=5 mm		
MFT-FOX HT 220 L 5	2097005	220 mm
MFT-FOX HT 240 L 5	2097008	240 mm
MFT-FOX HT 260 L 5	2097011	260 mm
MFT-FOX HT 280 L 5	2097014	280 mm
MFT-FOX HT 300 L 5	2097017	300 mm
MFT-FOX HT 320 L 5	2097020	320 mm
SCREWS D=6,5 mm		
MFT-FOX HT 220 L 6,5	2097006	220 mm
MFT-FOX HT 240 L 6,5	2097009	240 mm
MFT-FOX HT 260 L 6,5	2097012	260 mm
MFT-FOX HT 280 L 6,5	2097015	280 mm
MFT-FOX HT 300 L 6,5	2097018	300 mm
MFT-FOX HT 320 L 6,5	2097021	320 mm
ANCHORS D=11 mm		
MFT-FOX HT 220 L 11	2097007	220 mm
MFT-FOX HT 240 L 11	2097010	240 mm
MFT-FOX HT 260 L 11	2097013	260 mm
MFT-FOX HT 280 L 11	2097016	280 mm
MFT-FOX HT 300 L 11	2097019	300 mm
MFT-FOX HT 320 L 11	2097022	320 mm
MFT-FOX HI 300 M 11	2084357	300 mm

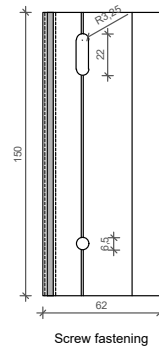
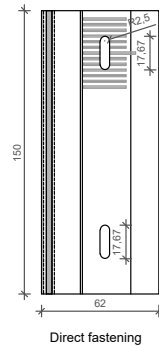
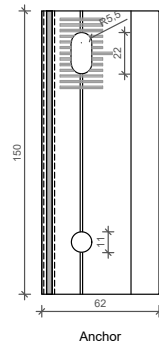
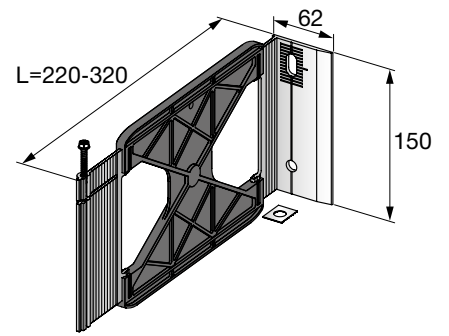

BRACKET PROFILE ADJUSTMENT

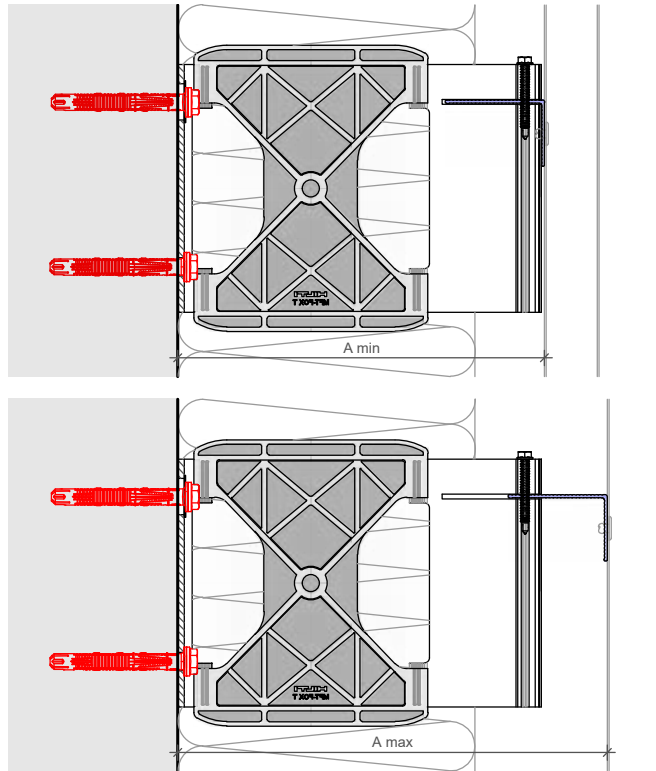

Profiles	MFT-T 60x80x1,8 6m 60x100x1,8 6m 60x120x1,8 6m		MFT-T 40x80x1,8 6m		MFT-L 60x40x1,8 6m		MFT-L 40x40x1,8 6m	
	A min*	A max*	A min*	A max*	A min*	A max*	A min*	A max*
Brackets								
MFT-FOX HT 140 M 6,5/11	141.8	181.8	141.8	161.8	141.8	181.8	141.8	161.8
MFT-FOX HT 160 M 6,5/11	161.8	201.8	161.8	181.8	161.8	201.8	161.8	181.8
MFT-FOX HT 180 M 6,5/11	181.8	221.8	181.8	201.8	181.8	221.8	181.8	201.8
MFT-FOX HT 200 M 6,5/11	201.8	241.8	201.8	221.8	201.8	241.8	201.8	221.8
MFT-FOX HT 220 L 6,5/11	221.8	261.8	221.8	241.8	221.8	261.8	221.8	241.8
MFT-FOX HT 240 L 6,5/11	241.8	281.8	241.8	261.8	241.8	281.8	241.8	261.8
MFT-FOX HT 260 L 6,5/11	261.8	301.8	261.8	281.8	261.8	301.8	261.8	281.8
MFT-FOX HT 280 L 6,5/11	281.8	321.8	281.8	301.8	281.8	321.8	281.8	301.8
MFT-FOX HT 300 L 6,5/11	301.8	341.8	301.8	321.8	301.8	341.8	301.8	321.8
MFT-FOX HT 320 L 6,5/11	321.8	361.8	321.8	341.8	321.8	361.8	321.8	341.8

* The distance shown is valid for profile thickness of 1,8 mm..



This is an interactive page! Click on the move-back button to jump back to the CONTENT AND OVERVIEW.

PRODUCTS RANGE

Bracket fasteners

HUS-HR



HRD-H



HST-R



HSA-R



HIT-HY 270



HIT-HY 200-A



S-MP 53S



S-MD 51S / S-MD 53S / S-MD 55S



Direct fastening



Brackets

MFT-FOX HT Medium



MFT-FOX HT Large



PRODUCTS RANGE

Profiles

MFT-L



MFT-T



Profile fastener

S-AD



Accessories

MFT-ISO



Insulation fasteners

Insulation fasteners

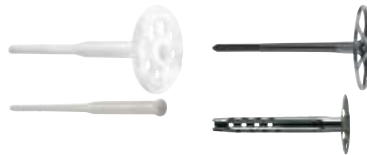



Hilti Corporation
9494 Schaan Liechtenstein
P +423-234 2111

www.facebook.com/hiltigroup
www.hilti.group